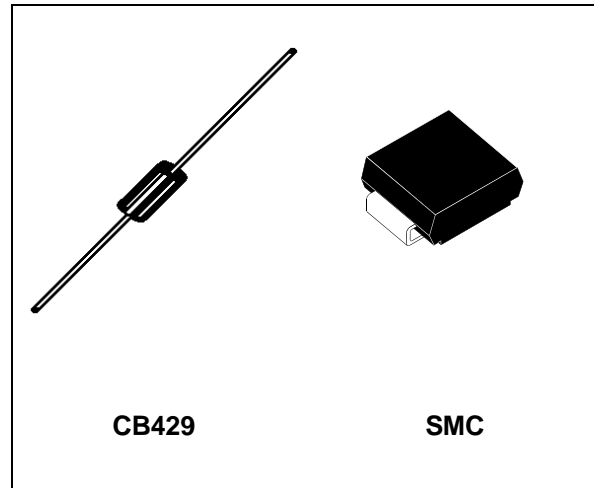


### FEATURES

- UNIDIRECTIONAL TRANSIL DIODE
- PEAK PULSE POWER : 1500 W (10/1000μs)
- REVERSE STAND OFF VOLTAGE : 5 V
- LOW CLAMPING FACTOR
- FAST RESPONSE TIME
- UL RECOGNIZED

### DESCRIPTION

The 1N5908 and SM5908 are dedicated to the 5 V logic circuit protection (TTL and CMOS technologies). Their low clamping voltage at high current level guarantees excellent protection for sensitive components.



### ABSOLUTE MAXIMUM RATINGS (T<sub>amb</sub> = 25°C).

Symbol	Parameter		Value	Unit
P <sub>PP</sub>	Peak pulse power dissipation (see note1)	T <sub>j</sub> initial = T <sub>amb</sub>	1500	W
P	Power dissipation on infinite heatsink	T <sub>amb</sub> = 75°C	5	W
I <sub>FSM</sub>	Non repetitive surge peak forward current for unidirectional types	t <sub>p</sub> = 10ms T <sub>j</sub> initial = T <sub>amb</sub>	200	A
T <sub>stg</sub> T <sub>j</sub>	Storage temperature range Maximum junction temperature		- 65 to + 175 175	°C °C
T <sub>L</sub>	Maximum lead temperature for soldering during 10s (at 5mm from case for CB429)	CB429 SMC	230 260	°C °C

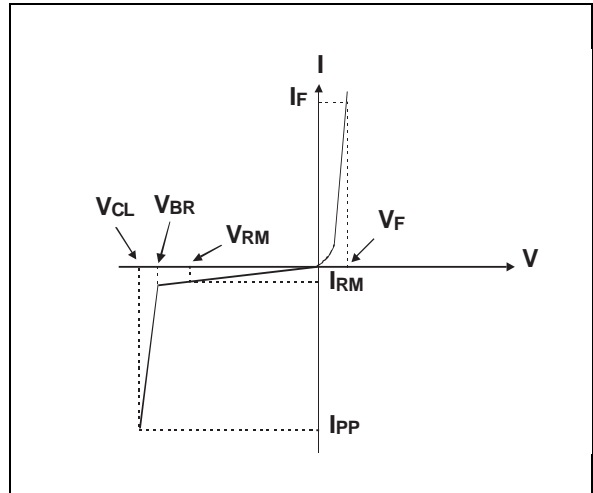
**Note 1** : For a surge greater than the maximum values, the diode will fail in short-circuit.

### THERMAL RESISTANCES

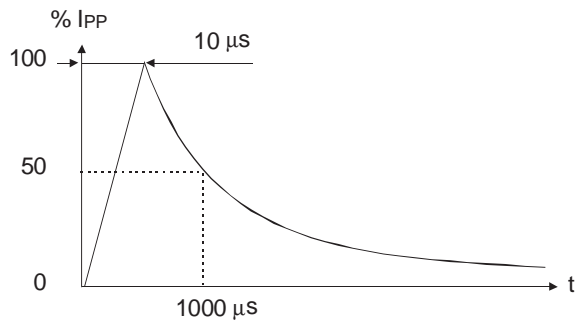
Symbol	Parameter		Value	Unit	
R <sub>th (j-l)</sub>	Junction to leads		20	°C/W	
R <sub>th (j-a)</sub>	Junction to ambient on printed circuit.	L lead = 10 mm	CB429	75	°C/W
		On recommended pad layout	SMC	75	°C/W

**ELECTRICAL CHARACTERISTICS**( $T_{amb} = 25^{\circ}\text{C}$ )

Symbol	Parameter
$V_{RM}$	Stand-off voltage
$V_{BR}$	Breakdown voltage
$V_{CL}$	Clamping voltage
$I_{RM}$	Leakage current @ $V_{RM}$
$I_{PP}$	Peak pulse current
$\alpha T$	Voltage temperature coefficient
$V_F$	Forward voltage



Types	$I_{RM} @ V_{RM}$ max		$V_{BR} @ I_R$ min note2		$V_{CL} @ I_{PP}$ max 10/1000 $\mu\text{s}$		$V_{CL} @ I_{PP}$ max 10/1000 $\mu\text{s}$		$V_{CL} @ I_{PP}$ max 10/1000 $\mu\text{s}$		$\alpha T$ max note3	C typ note4
	$\mu\text{A}$	V	V	mA	V	A	V	A	V	A	$10^{-4}/^{\circ}\text{C}$	pF
1N5908 SM5908	300	5	6	1	7.6	30	8	60	8.5	120	5.7	9500



- Note 2 :** Pulse test :  $t_p < 50\text{ms}$
- Note 3 :**  $\Delta V_{BR} = \alpha T * (T_{amb} - 25) * V_{BR} (25^{\circ}\text{C})$ .
- Note 4 :**  $V_R = 0\text{V}, F = 1\text{MHz}$

**Fig. 1:** Peak pulse power dissipation versus initial junction temperature (printed circuit board).

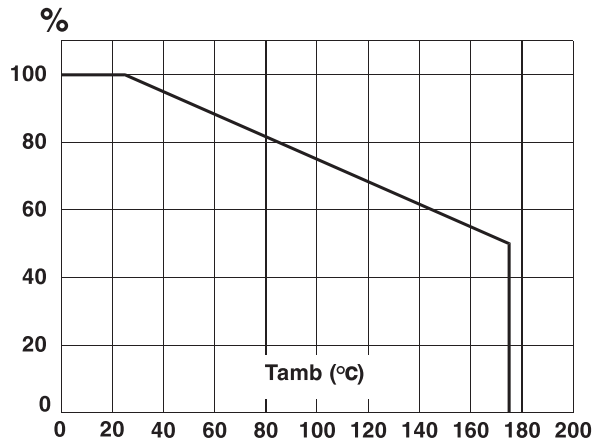


Fig. 2 : Peak pulse power versus exponential pulse duration.

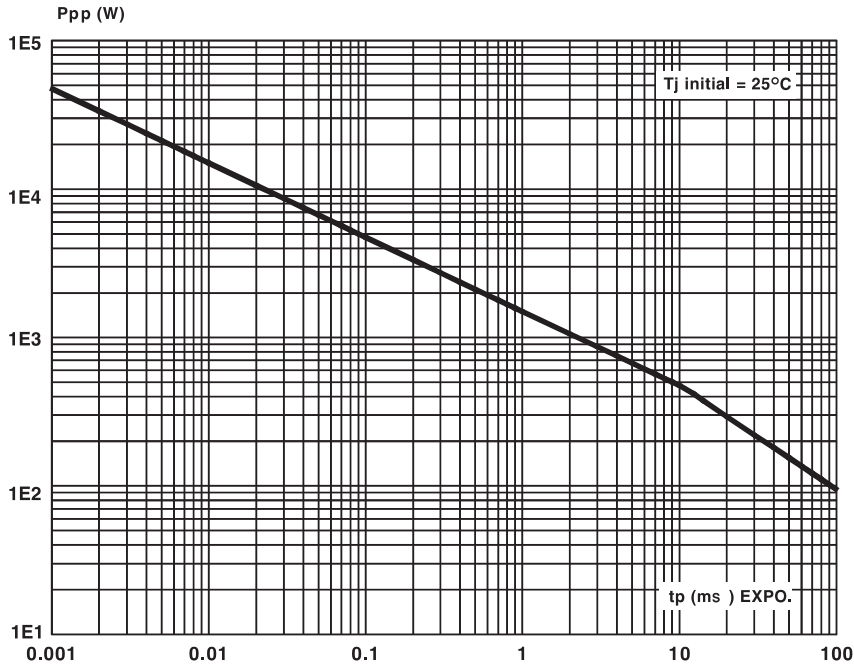
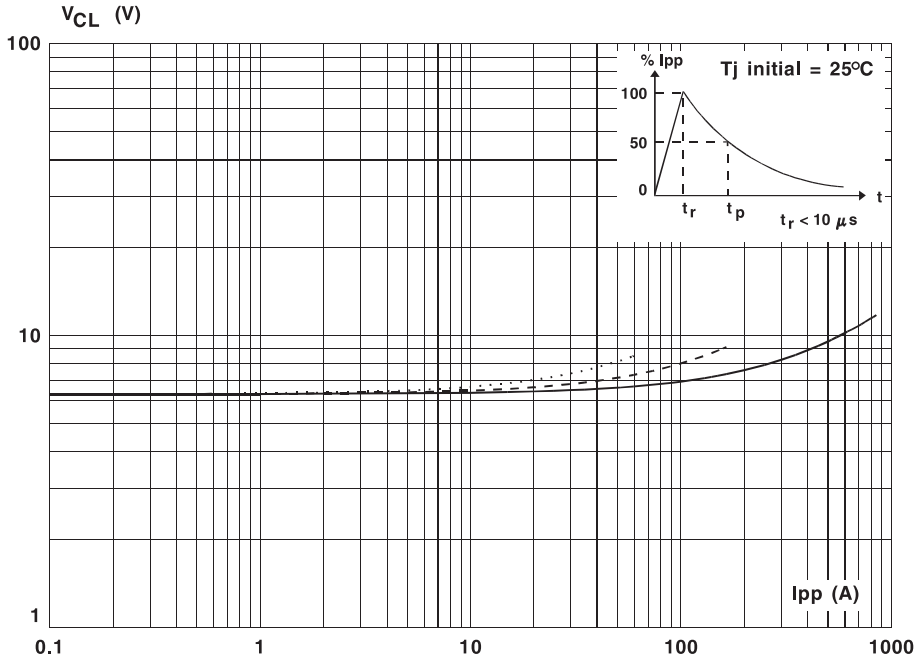


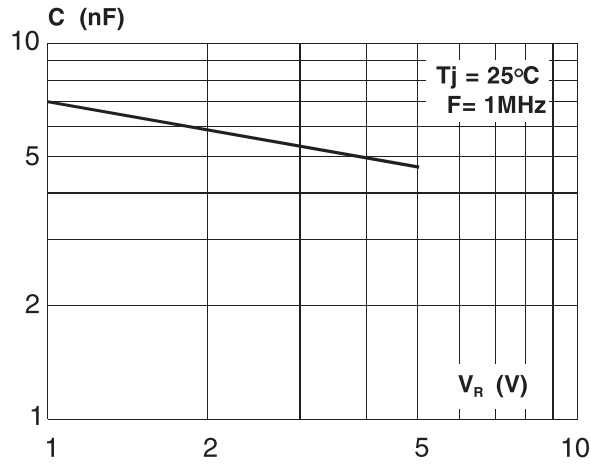
Fig. 3 : Clamping voltage versus peak pulse current.  
 Exponential waveform  $t_p = 10\text{ ms}$ .....  
 $t_p = 1\text{ ms}$ -----  
 $t_p = 20\ \mu\text{s}$ \_\_\_\_\_



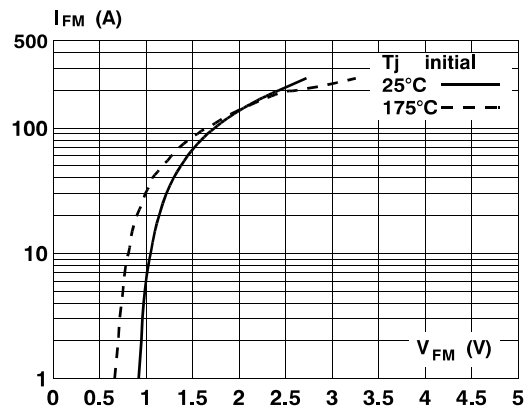
**Note :** The curves of the figure 3 are specified for a junction temperature of 25 °C before surge.  
 The given results may be extrapolated for other junction temperatures by using the following formula :  
 $\Delta V_{BR} = \alpha T \cdot (T_{amb} - 25) \cdot V_{BR} (25^\circ\text{C})$ .

# 1N5908/SM5908

**Fig. 4 :** Capacitance versus reverse applied voltage (typical values).

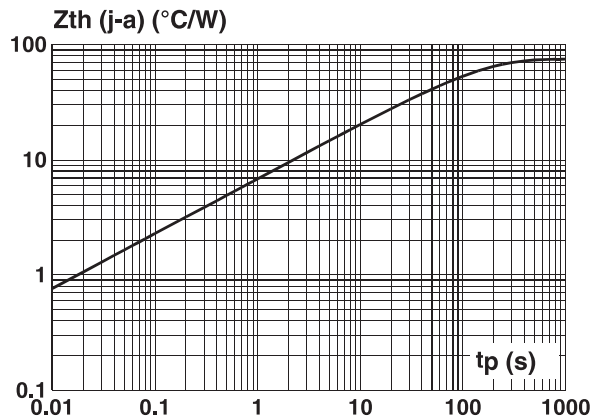


**Fig. 5 :** Peak forward voltage drop versus peak forward current.

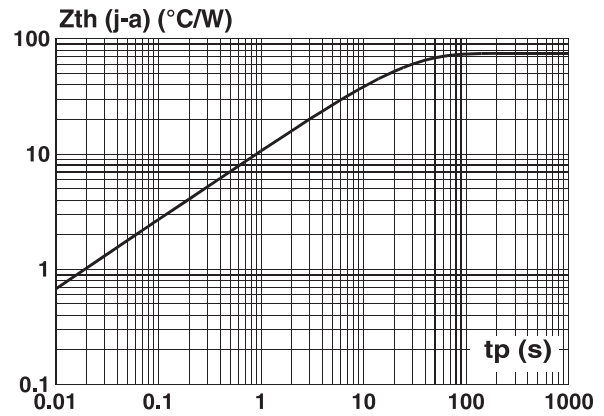


**Fig. 6a/6b :** Transient thermal impedance junction-ambient versus pulse duration.

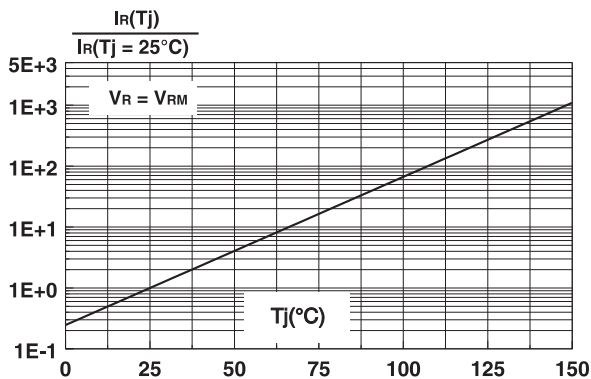
**Fig. 6a :** CB429 Package.  
(For FR4 PC Board with  $L_{lead} = 10\text{ mm}$ )



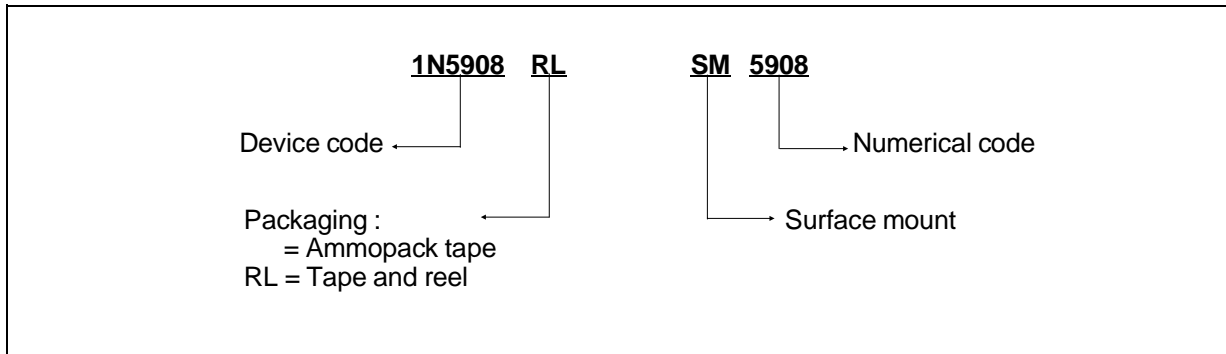
**Fig. 6b :** SMC Package.  
Mounting on FR4 PC Board with recommended pad layout.



**Fig. 7 :** Relative variation of leakage current versus junction temperature.



**ORDER CODE**



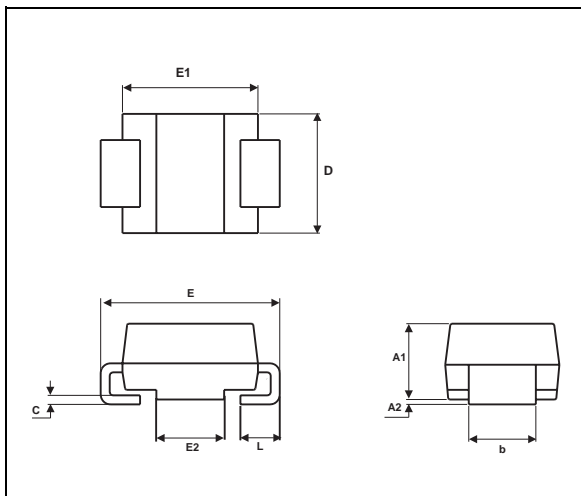
**MARKING** : Logo, type code and cathode band

Package	Type	Marking
SMC	SM5908	MDC
CB429	1N5908	1N5908

A white band indicates the cathode

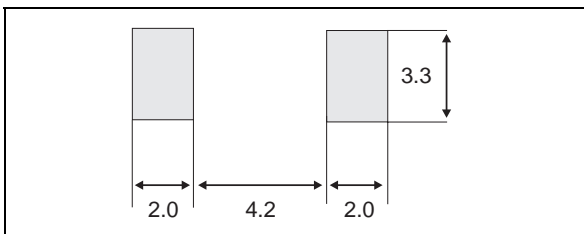
**PACKAGE MECHANICAL DATA**

**SMC (Plastic)**



REF.	DIMENSIONS			
	Millimeters		Inches	
	Min.	Max.	Min.	Max.
A1	1.90	2.45	0.075	0.096
A2	0.05	0.20	0.002	0.008
b	2.90	3.2	0.114	0.126
c	0.15	0.41	0.006	0.016
E	7.75	8.15	0.305	0.321
E1	6.60	7.15	0.260	0.281
E2	4.40	4.70	0.173	0.185
D	5.55	6.25	0.218	0.246
L	0.75	1.60	0.030	0.063

**FOOT PRINT (in millimeters)**



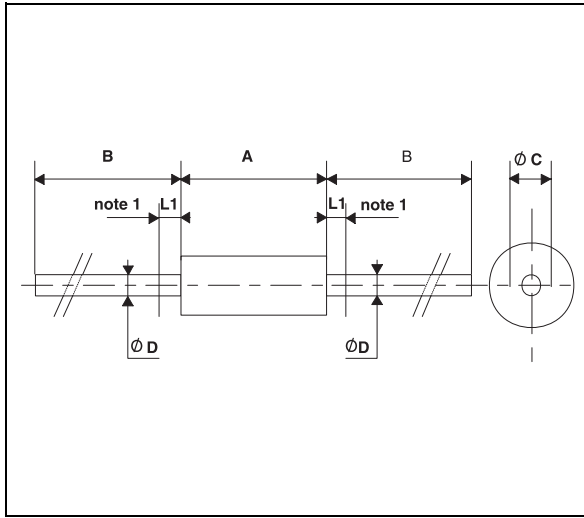
**Packaging** : Standard packaging is in tape and reel.

**Weight** = 0.25 g.

# 1N5908/SM5908

## PACKAGE MECHANICAL DATA

CB429 (Plastic)



REF.	DIMENSIONS					
	Millimeters			Inches		
	Min.	Typ.	Max.	Min.	Typ.	Max.
A	9.45	9.50	9.80	0.372	0.374	0.386
B	26			1.024		
Ø C	4.90	5.00	5.10	0.193	0.197	0.201
Ø D	0.94	1.00	1.06	0.037	0.039	0.042
L1			1.27			0.050
Note : The lead is not controlled within zone L <sub>1</sub>						

**Packaging** : Standard packaging is in tape and reel.

**Weight** = 0.85 g.

Information furnished is believed to be accurate and reliable. However, STMicroelectronics assumes no responsibility for the consequences of use of such information nor for any infringement of patents or other rights of third parties which may result from its use. No license is granted by implication or otherwise under any patent or patent rights of STMicroelectronics. Specifications mentioned in this publication are subject to change without notice. This publication supersedes and replaces all information previously supplied. STMicroelectronics products are not authorized for use as critical components in life support devices or systems without express written approval of STMicroelectronics.

The ST logo is a registered trademark of STMicroelectronics

© 1999 STMicroelectronics - Printed in Italy - All rights reserved.

STMicroelectronics GROUP OF COMPANIES

Australia - Brazil - China - Finland - France - Germany - Hong Kong - India - Italy - Japan - Malaysia  
Malta - Morocco - Singapore - Spain - Sweden - Switzerland - United Kingdom - U.S.A.

<http://www.st.com>

This datasheet has been download from:

[www.datasheetcatalog.com](http://www.datasheetcatalog.com)

Datasheets for electronics components.