

Silicon PNP Power Transistors

2SA1494

**DESCRIPTION**

- With MT-200 package
- Complement to type 2SC3858

**APPLICATIONS**

- Audio and general purpose

**PINNING(see Fig.2)**

PIN	DESCRIPTION
1	Base
2	Collector;connected to mounting base
3	Emitter

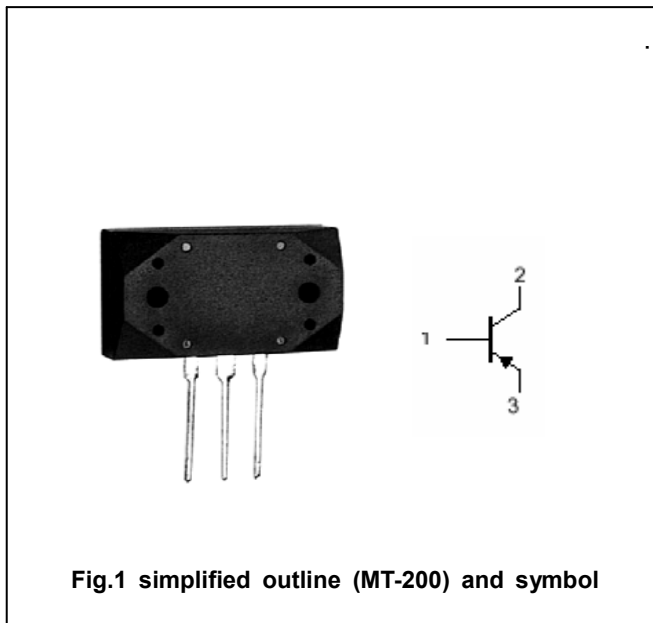

Fig.1 simplified outline (MT-200) and symbol

**Absolute maximum ratings (Ta=25°C)**

SYMBOL	PARAMETER	CONDITIONS	VALUE	UNIT
V <sub>CBO</sub>	Collector-base voltage	Open emitter	-200	V
V <sub>CEO</sub>	Collector-emitter voltage	Open base	-200	V
V <sub>EBO</sub>	Emitter-base voltage	Open collector	-6	V
I <sub>C</sub>	Collector current		-17	A
I <sub>B</sub>	Base current		-5	A
P <sub>C</sub>	Collector power dissipation	T <sub>C</sub> =25°C	200	W
T <sub>j</sub>	Junction temperature		150	°C
T <sub>stg</sub>	Storage temperature		-55~150	°C

## Silicon PNP Power Transistors

## 2SA1494

## CHARACTERISTICS

T<sub>j</sub>=25°C unless otherwise specified

SYMBOL	PARAMETER	CONDITIONS	MIN	TYP.	MAX	UNIT
V <sub>(BR)CEO</sub>	Collector-emitter breakdown voltage	I <sub>C</sub> =-50mA; I <sub>B</sub> =0	-200			V
V <sub>CEsat</sub>	Collector-emitter saturation voltage	I <sub>C</sub> =-10 A; I <sub>B</sub> =-1 A			-2.5	V
I <sub>CBO</sub>	Collector cut-off current	V <sub>CB</sub> =-200V; I <sub>E</sub> =0			-100	μA
I <sub>EBO</sub>	Emitter cut-off current	V <sub>EB</sub> =-6V; I <sub>C</sub> =0			-100	μA
h <sub>FE</sub>	DC current gain	I <sub>C</sub> =-8A ; V <sub>CE</sub> =-4V	50		180	
f <sub>T</sub>	Transition frequency	I <sub>C</sub> =-1A ; V <sub>CE</sub> =-12V		20		MHz
C <sub>OB</sub>	Output capacitance	I <sub>E</sub> =0; V <sub>CB</sub> =-10V; f=1MHz		500		pF

## Switching times

t <sub>on</sub>	Turn-on time	I <sub>C</sub> =-10A; R <sub>L</sub> =4Ω I <sub>B1</sub> =-I <sub>B2</sub> =-1A V <sub>CC</sub> =-40V		0.60		μs
t <sub>s</sub>	Storage time			0.90		μs
t <sub>f</sub>	Fall time			0.20		μs

◆ h<sub>FE</sub> classifications

Y	P	G
50-100	70-140	90-180

Silicon PNP Power Transistors

2SA1494

PACKAGE OUTLINE

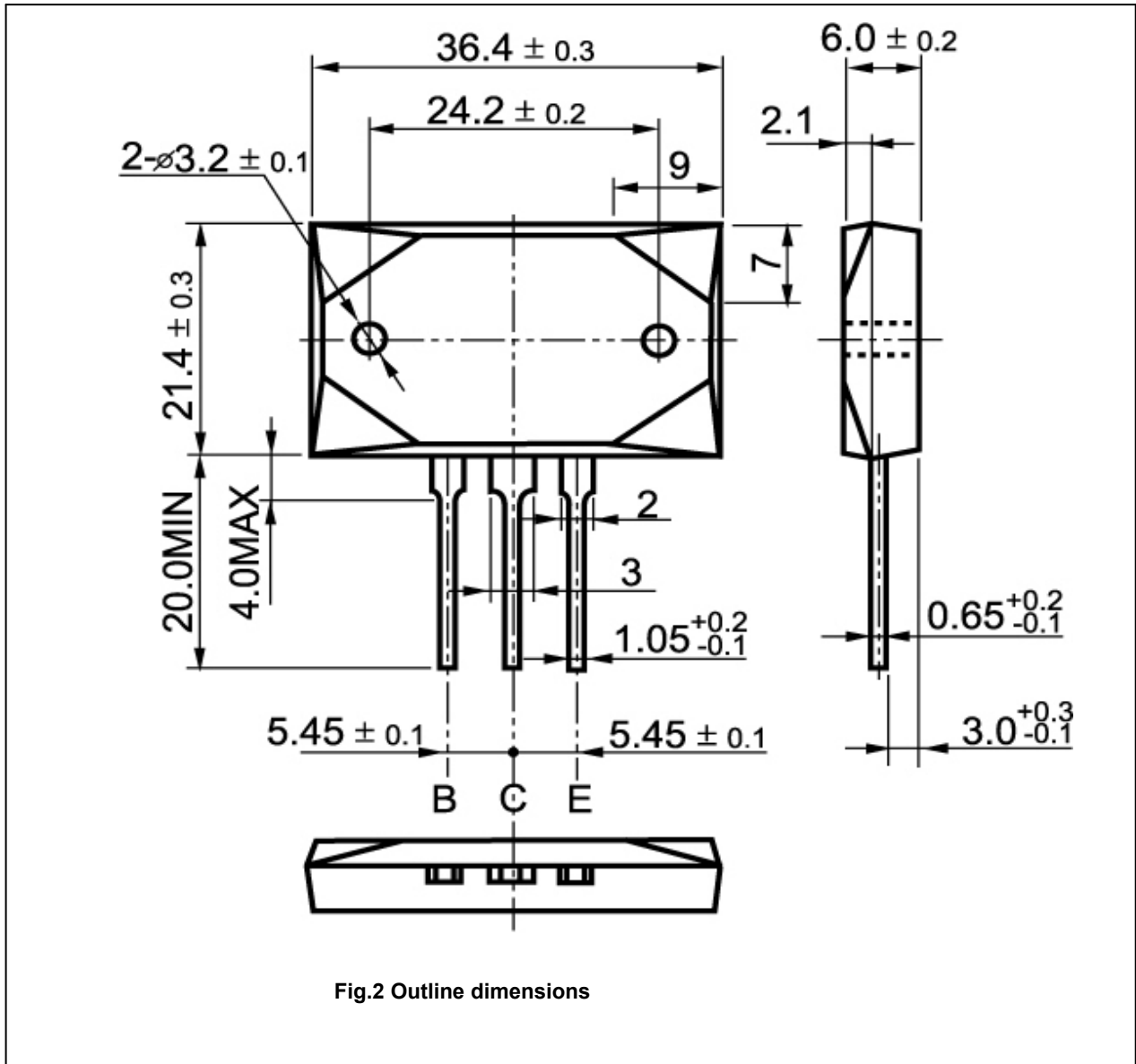

Fig.2 Outline dimensions

Silicon PNP Power Transistors

2SA1494

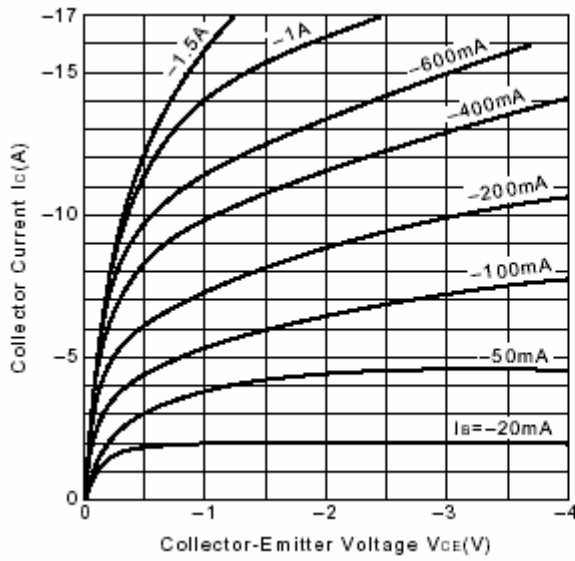

Fig.3 Static Characteristic

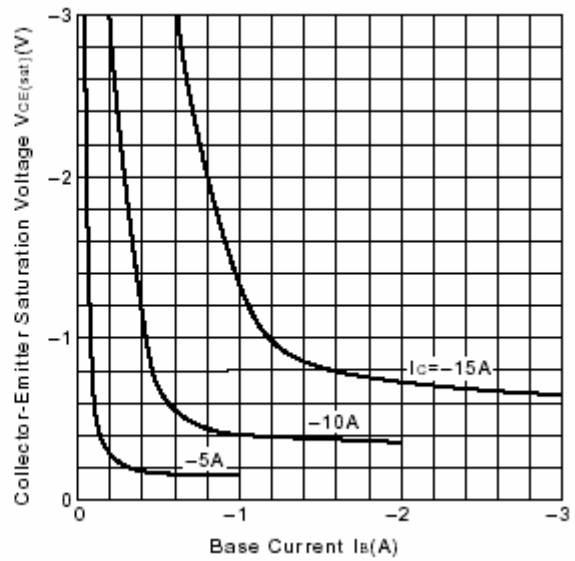

Fig.4  $V_{CE(sat)}$ - $I_B$  Characteristics

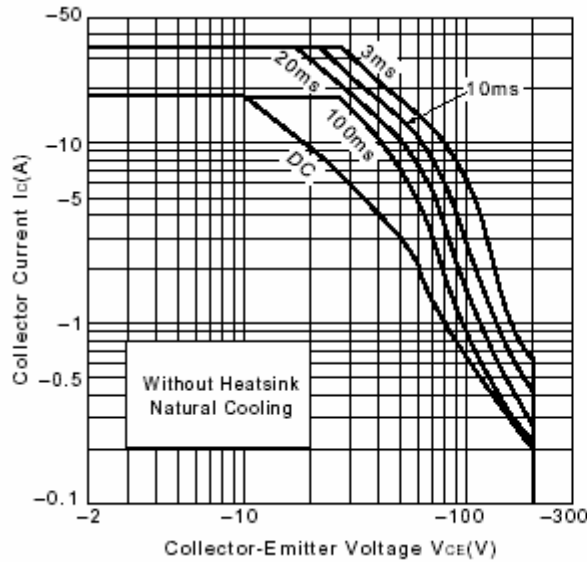

Fig.5 Safe Operating Area

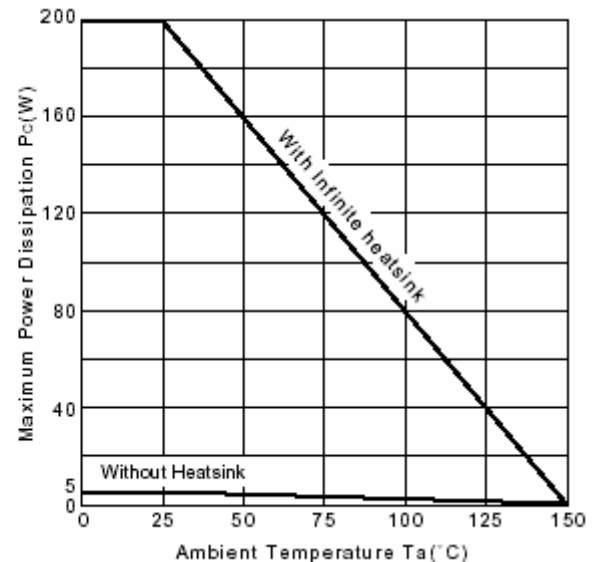

Fig.6  $P_c$ - $T_a$  Derating

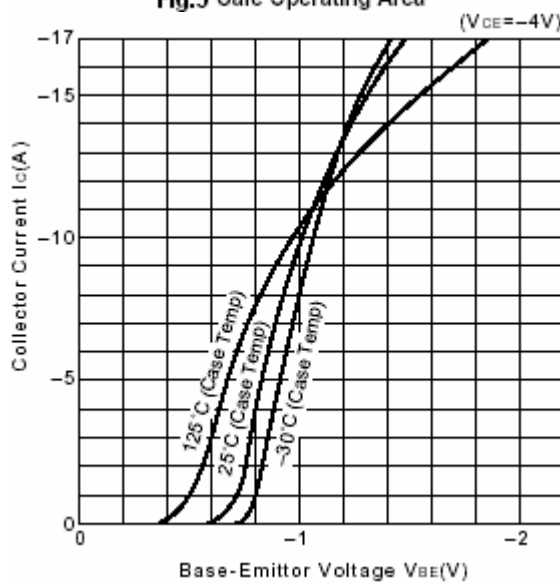

Fig.7  $I_C$ - $V_{BE}$

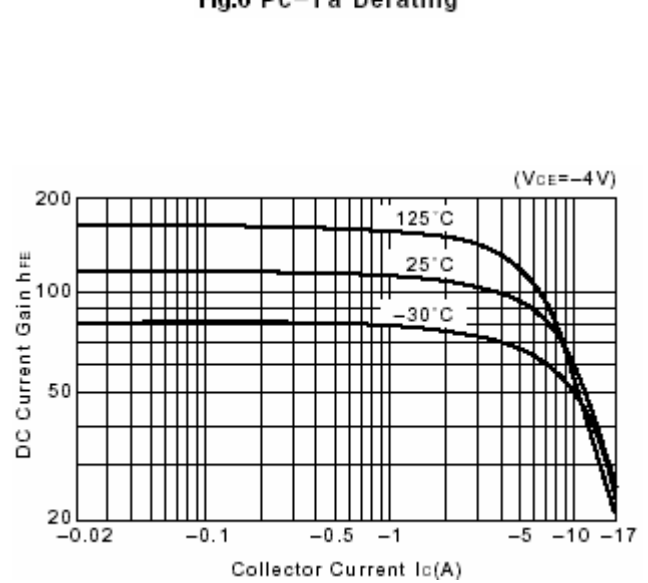

Fig.8 DC current Gain