

TOSHIBA TRANSISTOR SILICON NPN TRIPLE DIFFUSED MESA TYPE

# 2SC5144

HORIZONTAL DEFLECTION OUTPUT FOR HIGH RESOLUTION DISPLAY, COLOR TV

HIGH SPEED SWITCHING APPLICATIONS

- High Speed :  $t_f = 0.15 \mu s$  (Typ.)
- High Voltage :  $V_{CBO} = 1700 V$
- Low Saturation Voltage :  $V_{CE(sat)} = 3 V$  (Max.)

MAXIMUM RATINGS ( $T_a = 25^\circ C$ )

CHARACTERISTIC	SYMBOL	RATING	UNIT
Collector-Base Voltage	$V_{CBO}$	1700	V
Collector-Emitter Voltage	$V_{CEO}$	600	V
Emitter-Base Voltage	$V_{EBO}$	5	V
Collector Current	DC	$I_C$	20
	Pulse	$I_{CP}$	40
Base Current	$I_B$	10	A
Collector Power Dissipation ( $T_c = 25^\circ C$ )	$P_C$	200	W
Junction Temperature	$T_j$	150	$^\circ C$
Storage Temperature Range	$T_{stg}$	-55~150	$^\circ C$

Unit in mm

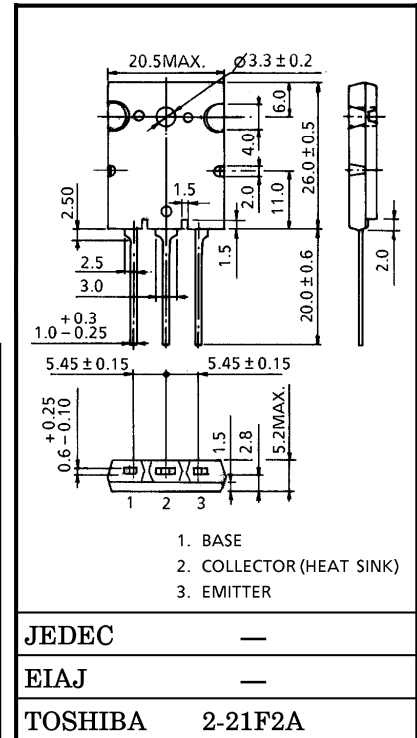

Weight : 9.75 g (Typ.)

ELECTRICAL CHARACTERISTICS ( $T_a = 25^\circ C$ )

CHARACTERISTIC	SYMBOL	TEST CONDITION	MIN.	TYP.	MAX.	UNIT
Collector Cut-off Current	$I_{CBO}$	$V_{CB} = 1700 V, I_E = 0$	—	—	1	mA
Emitter Cut-off Current	$I_{EBO}$	$V_{EB} = 5 V, I_C = 0$	—	—	10	$\mu A$
Collector-Emitter Breakdown Voltage	$V_{(BR)CEO}$	$I_C = 10 mA, I_B = 0$	600	—	—	V
DC Current Gain	$h_{FE(1)}$	$V_{CE} = 5 V, I_C = 2 A$	10	—	30	—
	$h_{FE(2)}$	$V_{CE} = 5 V, I_C = 11 A$	4.5	—	8.5	
Collector-Emitter Saturation Voltage	$V_{CE(sat)}$	$I_C = 11 A, I_B = 2.75 A$	—	—	3	V
Base-Emitter Saturation Voltage	$V_{BE(sat)}$	$I_C = 11 A, I_B = 2.75 A$	—	1.0	1.3	V
Transition Frequency	$f_T$	$V_{CE} = 10 V, I_E = 0.1 A$	—	1.7	—	MHz
Collector Output Capacitance	$C_{ob}$	$V_{CB} = 10 V, I_E = 0, f = 1 MHz$	—	290	—	pF
Switching Time (Fig.1)	Storage Time	$t_{stg}$	—	2.5	4.0	$\mu s$
	Fall Time	$t_f$	—	0.15	0.3	

961001EAA2

- TOSHIBA is continually working to improve the quality and the reliability of its products. Nevertheless, semiconductor devices in general can malfunction or fail due to their inherent electrical sensitivity and vulnerability to physical stress. It is the responsibility of the buyer, when utilizing TOSHIBA products, to observe standards of safety, and to avoid situations in which a malfunction or failure of a TOSHIBA product could cause loss of human life, bodily injury or damage to property. In developing your designs, please ensure that TOSHIBA products are used within specified operating ranges as set forth in the most recent products specifications. Also, please keep in mind the precautions and conditions set forth in the TOSHIBA Semiconductor Reliability Handbook.
- The information contained herein is presented only as a guide for the applications of our products. No responsibility is assumed by TOSHIBA CORPORATION for any infringements of intellectual property or other rights of the third parties which may result from its use. No license is granted by implication or otherwise under any intellectual property or other rights of TOSHIBA CORPORATION or others.
- The information contained herein is subject to change without notice.

Fig.1 SWITCHING TIME TEST CIRCUIT

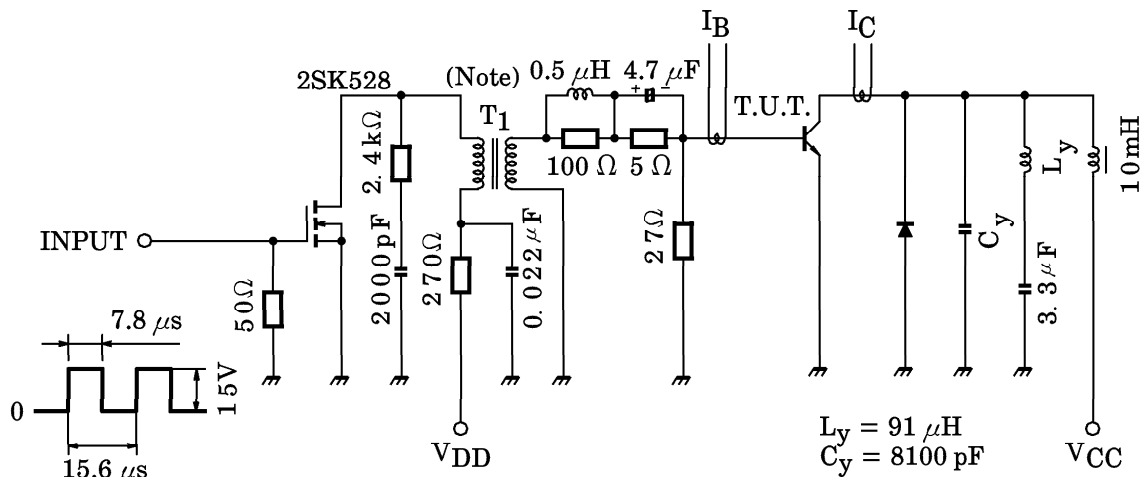

BASE CURRENT

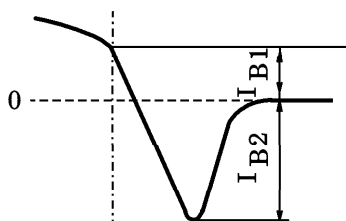

COLLECTOR CURRENT

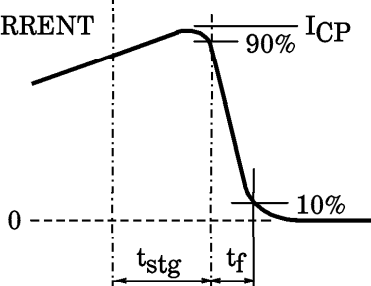

Base Current Gradient

$$dI_B / dt = \frac{I_{B1} + I_{B2}}{t_{stg}} \text{ (A / } \mu\text{s)}$$

(Note) : Leakage Inductance of secondary winding L<sub>B</sub> is 1.2  $\mu$ H.

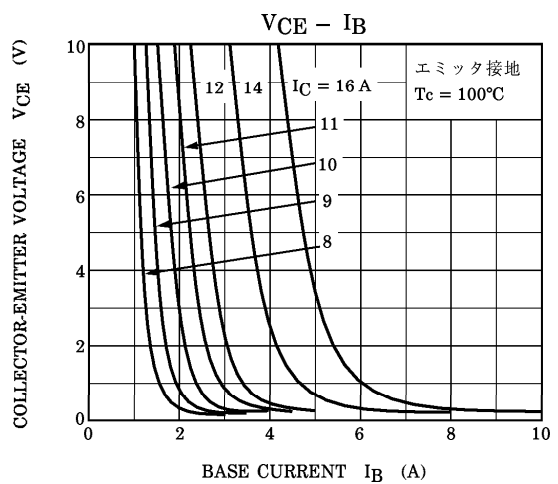
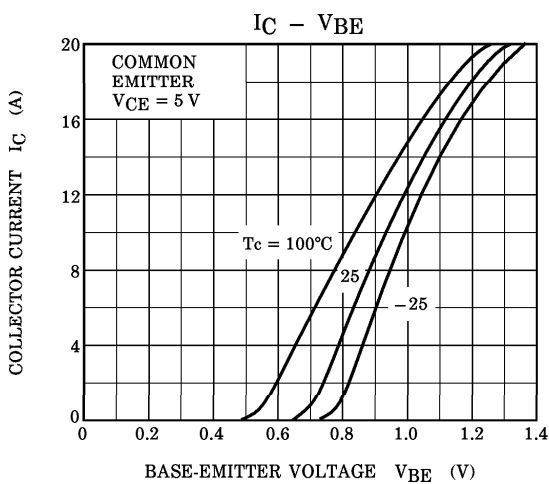
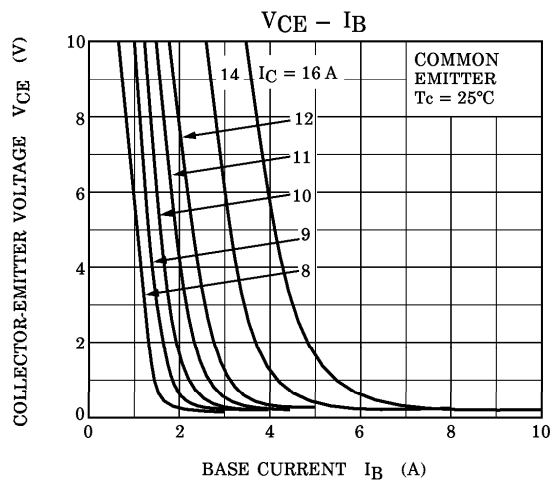
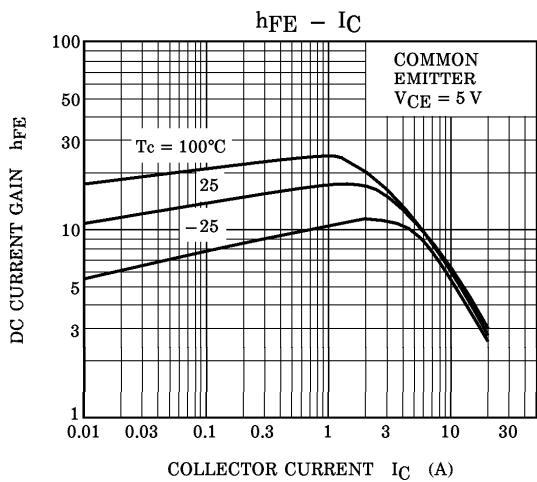
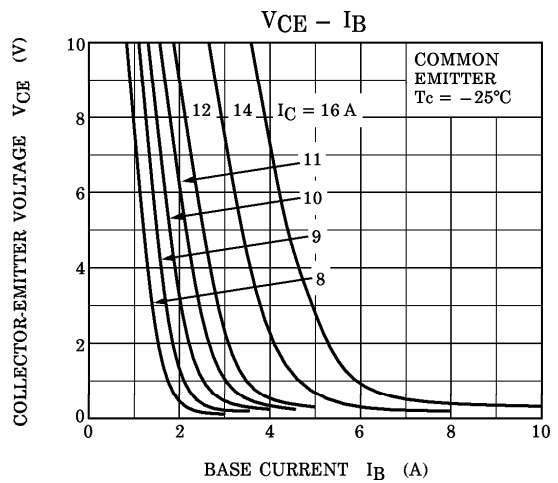
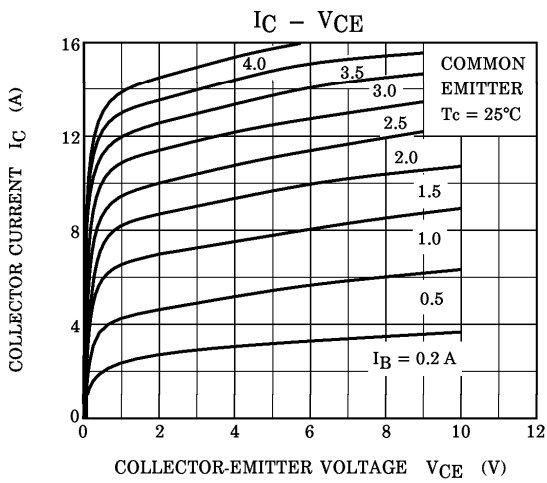

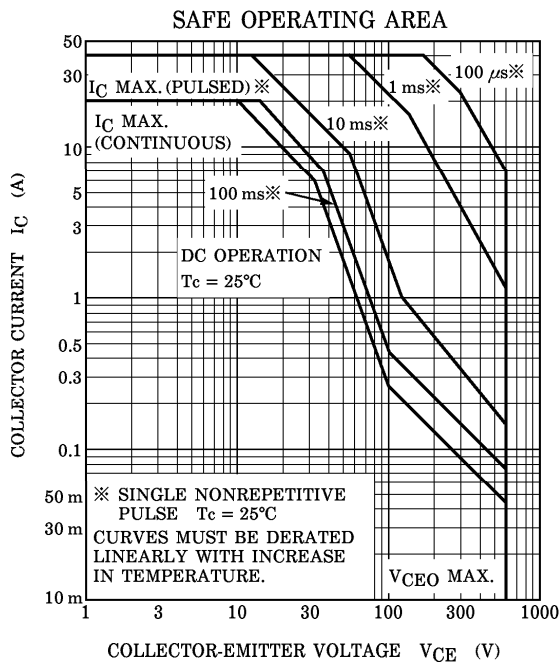
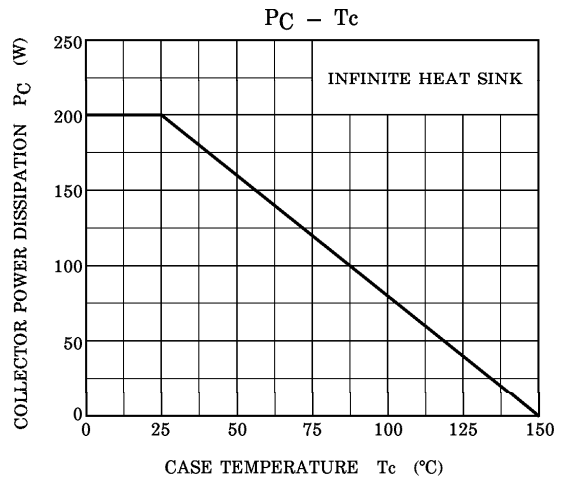
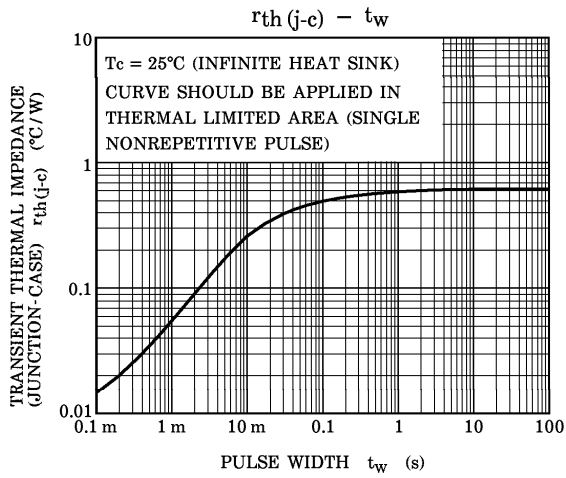

This datasheet has been download from:

[www.datasheetcatalog.com](http://www.datasheetcatalog.com)

Datasheets for electronics components.