

9097250 TOSHIBA (DISCRETE/OPTO)

56C 07966 D 7-33-13

SILICON NPN TRIPLE DIFFUSED MESA TYPE

2SD1428

COLOR TV HORIZONTAL OUTPUT APPLICATIONS.

FEATURES:

- . High Voltage : $V_{CBO}=1500V$
- . Low Saturation Voltage : $V_{CE(sat)}=5V(\text{Max.}) (I_C=5A, I_B=1A)$
- . High Speed : $t_f=1.0\mu s(\text{Max.})$
- . Built-in Damper Type
- . Glass Passivated Collector-Base Junction

MAXIMUM RATINGS ($T_c=25^\circ C$)

CHARACTERISTIC	SYMBOL	RATING	UNIT
Collector-Base Voltage	V_{CBO}	1500	V
Collector-Emitter Voltage	V_{CEO}	600	V
Emitter-Base Voltage	V_{EBO}	5	V
Collector Current	I_C	6	A
Emitter Current	I_E	-6	A
Collector Power Dissipation ($T_c=25^\circ C$)	P_C	80	W
Junction Temperature	T_j	150	$^\circ C$
Storage Temperature Range	T_{stg}	-55 ~ 150	$^\circ C$

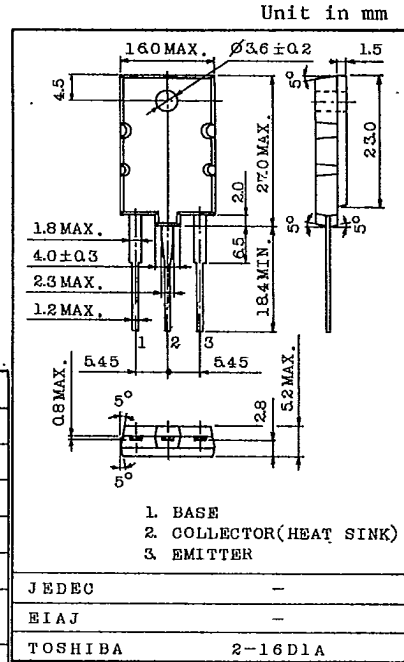

EQUIVALENT CIRCUIT

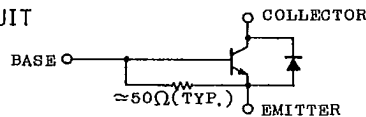

ELECTRICAL CHARACTERISTICS ($T_c=25^\circ C$)

CHARACTERISTIC	SYMBOL	TEST CONDITION	MIN.	TYP.	MAX.	UNIT
Collector Cut-off Current	I_{CBO}	$V_{CB}=500V, I_E=0$	-	-	10	μA
Emitter-Base Breakdown Voltage	$V_{(BR)EBO}$	$I_E=200mA, I_C=0$	5	-	-	V
DC Current Gain	h_{FE}	$V_{CE}=5V, I_C=1A$	8	12	-	
Collector-Emitter Saturation Voltage	$V_{CE(sat)}$	$I_C=5A, I_B=1A$	-	3	5	V
Base-Emitter Saturation Voltage	$V_{BE(sat)}$	$I_C=5A, I_B=1A$	-	-	1.5	V
Forward Voltage (Damper Diode)	$-V_F$	$I_F=6A$	-	1.6	2.0	V
Transition Frequency	f_T	$V_{CE}=10V, I_C=0.1A$	-	3	-	MHz
Collector Output Capacitance	C_{ob}	$V_{CB}=10V, I_E=0, f=1MHz$	-	165	-	pF
Fall Time (Fig.)	t_f	$I_{CP}=5A, I_{B1}(\text{end})=1A$	-	0.5	1.0	μs

TOSHIBA CORPORATION

9097250 TOSHIBA (DISCRETE/OPTO)

56C 07967 D T-33-13

2SD1428

Fig. t_f TEST CIRCUIT

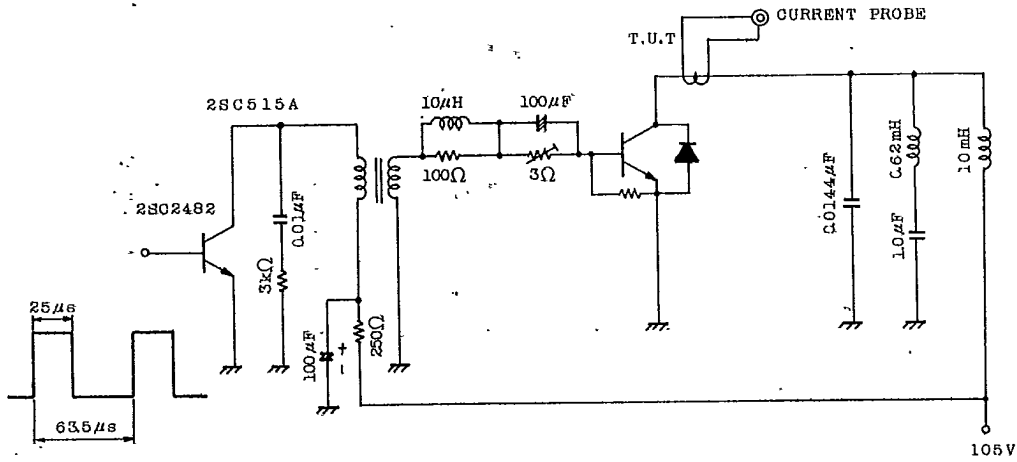

BASE CURRENT

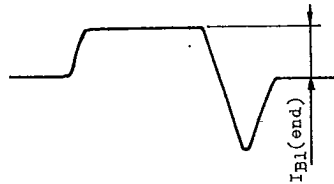

COLLECTOR CURRENT

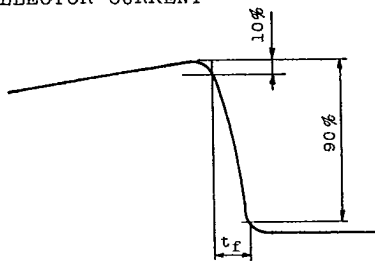

TOSHIBA CORPORATION

2SD1428

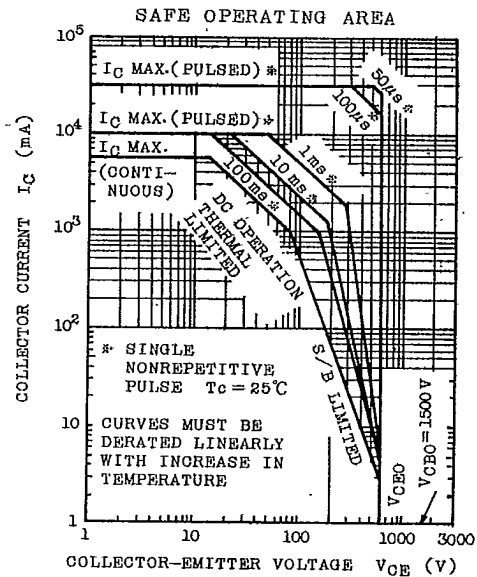
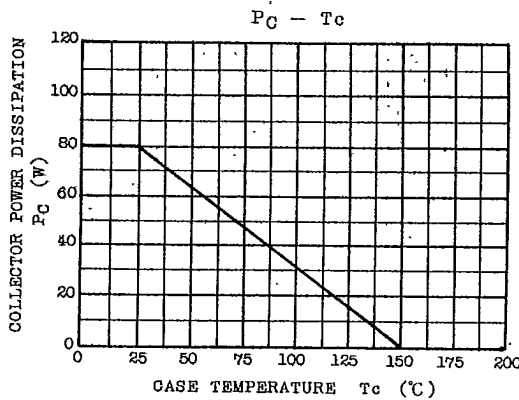
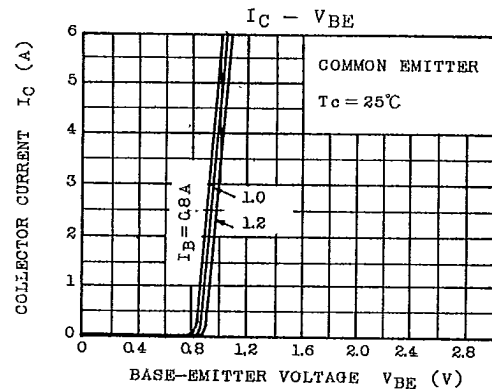
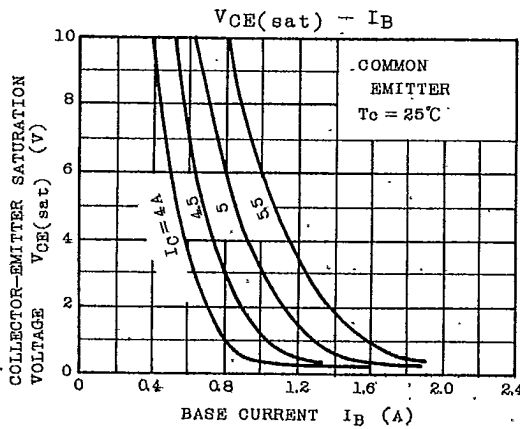
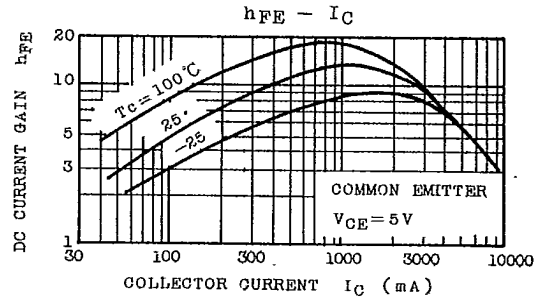
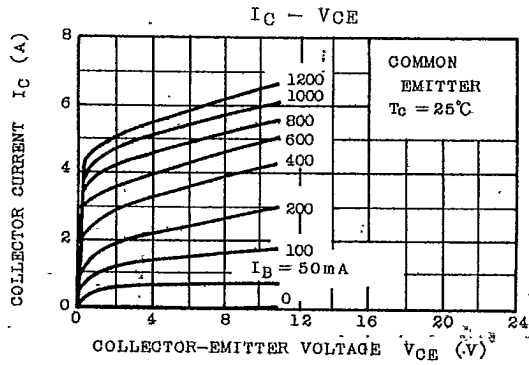

TOSHIBA CORPORATION