

UTC 2SD1609 NPN EPITAXIAL SILICON TRANSISTOR

NPN EPITAXIAL PLANAR TRANSISTOR

FEATURES

* Low frequency high voltage amplifier

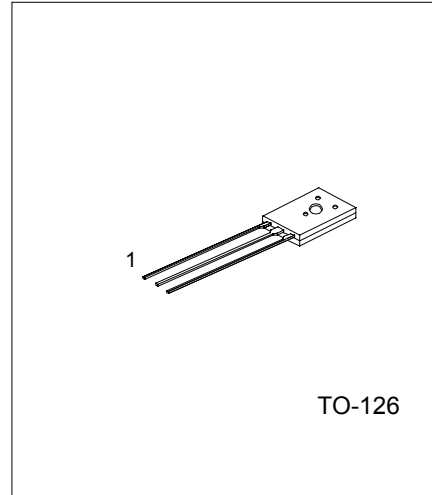

1:EMITTER 2:COLLECTOR 3:BASE

ABSOLUTE MAXIMUM RATINGS (Ta=25°C, unless otherwise specified)

PARAMETER	SYMBOL	MIN	MAX	UNIT
Collector-Base Voltage	BVCBO		160	V
Collector-Emitter Voltage	BVCEO		160	V
Emitter-Base Voltage	BVEBO		5	V
Collector Current	Ic		100	mA
Total Power Dissipation (Ta=25°C)	Ptot		1.25	W
Junction Temperature	Tj		150	°C
Storage Temperature	Tstg	-50	150	°C

ELECTRICAL CHARACTERISTICS (Ta=25°C, unless otherwise specified)

PARAMETER	SYMBOL	TEST CONDITIONS	MIN	TYP	MAX	UNIT
Collector-Base Voltage	BVCBO	Ic=10μA	160			V
Collector-Emitter Voltage	BVCEO	Ic=1mA	160			V
Emitter-Base Voltage	BVEBO	Ie=10μA	5			V
Collector Cut-off Current	ICBO	VCE=140V			10	μA
DC Current Gain	hFE1	VCE=5V, Ic=10mA	60		320	
	hFE2	VCE=5V, Ic=1mA	30			
Collector-Emitter Saturation Voltage	VCE(sat)	Ic=30mA, Ib=3mA			2	V
Base-Emitter On Voltage	VBE(on)	VCE=5V, Ic=10mA			1.5	V
Current Gain Bandwidth Product	fT	VCE=5V, Ic=10mA	145			MHz
Output Capacitance	Cob	VCE=10V, f=1MHz		3.8		pF

CLASSIFICATION OF hFE1

RANK	B	C	D
RANGE	60-120	100-200	160-320

UTC 2SD1609 NPN EPITAXIAL SILICON TRANSISTOR

CHARACTERISTICS CURVE

UTC 2SD1609 NPN EPITAXIAL SILICON TRANSISTOR

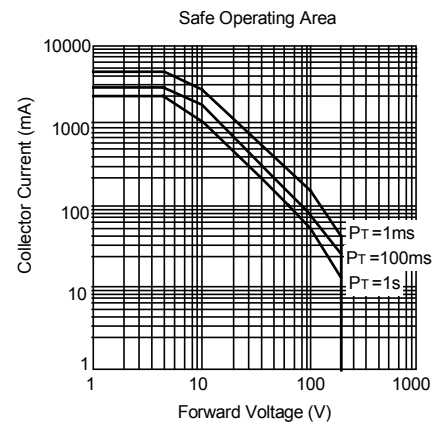
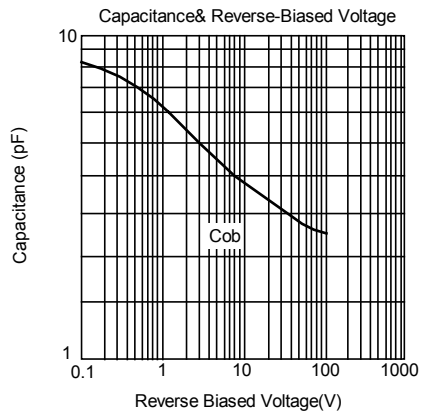
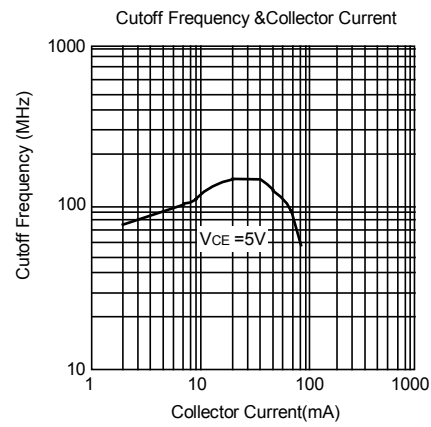
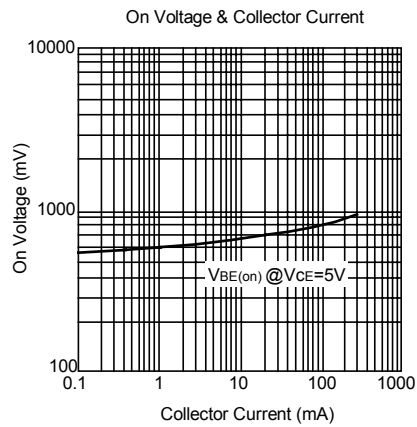
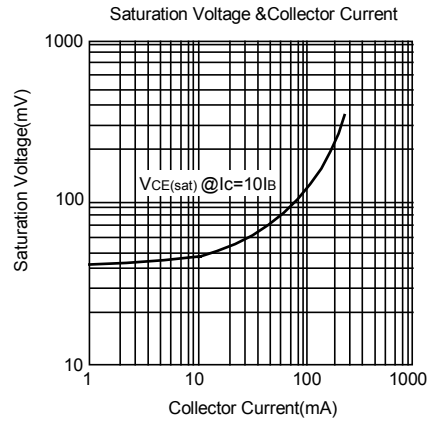
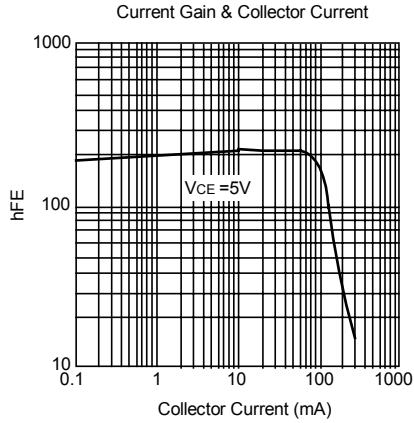

UTC 2SD1609 NPN EPITAXIAL SILICON TRANSISTOR

UTC assumes no responsibility for equipment failures that result from using products at values that exceed, even momentarily, rated values (such as maximum ratings, operating condition ranges, or other parameters) listed in products specifications of any and all UTC products described or contained herein. UTC products are not designed for use in life support appliances, devices or systems where malfunction of these products can be reasonably expected to result in personal injury. Reproduction in whole or in part is prohibited without the prior written consent of the copyright owner. The information presented in this document does not form part of any quotation or contract, is believed to be accurate and reliable and may be changed without notice.