

P & N-Channel 30-V (D-S) MOSFET

■ Features

- Low $r_{DS(on)}$ Provides Higher Efficiency and Extends Battery Life
- Miniature SO-8 Surface Mount Package Saves Board Space
- High power and current handling capability
- Low side high current DC-DC Converter applications

■ General Description

These miniature surface mount MOSFETs utilize High Cell Density process. Low $r_{DS(on)}$ assures minimal power loss and conserves energy, making this device ideal for use in power management circuitry. Typical applications are PWMDC-DC converters, power management in portable and battery-powered products such as computers, printers, battery charger, telecommunication power system, and telephones power system.

■ Product Summary

V_{DS} (V)	$r_{DS(on)}$ (m Ω)	I_D (A)
30	20@ $V_{GS}=4.5V$	8.4
	13.5@ $V_{GS}=10V$	10.0
-30	30@ $V_{GS}=-4.5V$	-6.8
	19@ $V_{GS}=-10V$	-8.5

■ Pin Assignments

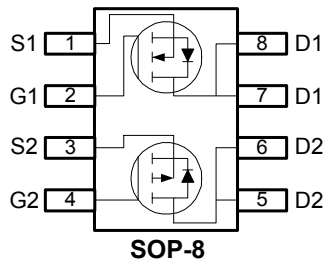

■ Pin Descriptions

Pin Name	Description
S1	Source (NMOS)
G1	Gate (NMOS)
D1	Drain (NMOS)
S2	Source (PMOS)
G2	Gate (PMOS)
D2	Drain (PMOS)

■ Ordering information

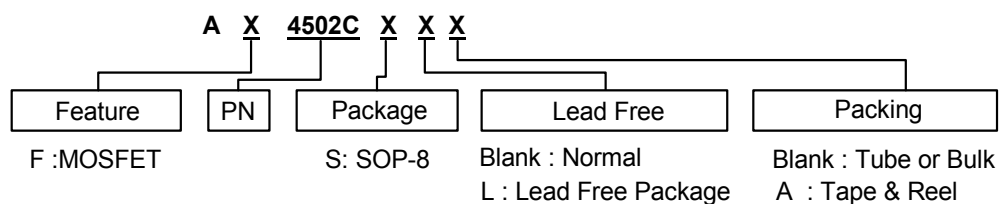



P & N-Channel 30-V (D-S) MOSFET

■ Absolute Maximum Ratings ($T_A=25^\circ\text{C}$ unless otherwise noted)

Symbol	Parameter	N-Channel	P-Channel	Units	
V_{DS}	Drain-Source Voltage	30	-30	V	
V_{GS}	Gate-Source Voltage	20	-25		
I_D	Continuous Drain Current (Note 1)	$T_A=25^\circ\text{C}$	10	-8.5	A
		$T_A=70^\circ\text{C}$	8.1	-6.8	
I_{DM}	Pulsed Drain Current (Note 2)	± 50	± 50	A	
I_S	Continuous Source Current (Diode Conduction) (Note 1)	2.3	-2.1	A	
P_D	Power Dissipation (Note 1)	$T_A=25^\circ\text{C}$	2.1	2.1	W
		$T_A=70^\circ\text{C}$	1.3	1.3	
T_J, T_{STG}	Operating Junction and Storage Temperature Range	-	-55 to 150	$^\circ\text{C}$	

■ Thermal Resistance Ratings

Symbol	Parameter	Maximum	Units
$R_{\theta JC}$	Maximum Junction-to-Case (Note 1)	40	$^\circ\text{C/W}$
$R_{\theta JA}$	Maximum Junction-to-Ambient (Note 1)	60	$^\circ\text{C/W}$

Note 1: surface Mounted on 1"x 1" FR4 Board.

Note 2: Pulse width limited by maximum junction temperature

■ Specifications ($T_A=25^\circ\text{C}$ unless otherwise noted)

Symbol	Parameter	Test Conditions	Limits				Unit
			Ch	Min.	Typ.	Max.	
Static							
$V_{(BR)DSS}$	Drain-Source breakdown Voltage	$V_{GS}=0V, I_D=250\mu\text{A}$	N	30	-	-	V
		$V_{GS}=0V, I_D=-250\mu\text{A}$	P	-30	-	-	
$V_{GS(th)}$	Gate-Threshold Voltage	$V_{DS}=V_{GS}, I_D=250\mu\text{A}$	N	1	1.95	3	V
		$V_{DS}=V_{GS}, I_D=-250\mu\text{A}$	P	-1.0	-1.6	-3	
I_{GSS}	Gate-Body Leakage	$V_{GS}=20V, V_{DS}=0V$	N	-	-	± 100	nA
		$V_{GS}=-20V, V_{DS}=0V$	P	-	-	± 100	
I_{DSS}	Zero Gate Voltage Drain Current	$V_{DS}=24V, V_{GS}=0V$	N	-	-	1	μA
		$V_{DS}=-24V, V_{GS}=0V$	P	-	-	-1	
$I_{D(on)}$	On-State Drain Current (Note 3)	$V_{DS}=5V, V_{GS}=10V$	N	20	-	-	A
		$V_{DS}=-5V, V_{GS}=-10V$	P	-50	-	-	
$r_{DS(on)}$	Drain-Source On-Resistance (Note 3)	$V_{GS}=10V, I_D=10A$	N	-	11	13.5	m Ω
		$V_{GS}=4.5V, I_D=8.4A$		-	15	20	
		$V_{GS}=-10V, I_D=-8.5A$	P	-	16	19	
		$V_{GS}=-4.5V, I_D=-6.8A$		-	26	30	
g_{fs}	Forward Transconductance (Note 3)	$V_{DS}=15V, I_D=10A$	N	-	40	-	S
		$V_{DS}=-15V, I_D=-9.5A$	P	-	31	-	



P & N-Channel 30-V (D-S) MOSFET

■ Specifications ($T_A=25^\circ\text{C}$ unless otherwise noted)

Symbol	Parameter	Test Conditions	Limits				Unit
			Ch	Min.	Typ.	Max.	
Dynamic							
Q_g	Total Gate Charge	N-Channel $V_{DS}=15\text{V}, V_{GS}=4.5\text{V}$	N	-	12	19	nC
			P	-	13	26	
Q_{gs}	Gate-Source Charge	I _D =10A P-Channel	N	-	3.3	-	
			P	-	5.8	-	
Q_{gd}	Gate-Drain Charge	$V_{DS}=-15\text{V}, V_{GS}=-4.5\text{V}$ I _D =-10A	N	-	4.5	-	
			P	-	12	-	
Switching							
$t_{d(on)}$	Turn-On Delay Time	N-Channel $V_{DD}=15, V_{GS}=10\text{V}$ I _D =1A, R _{GEN} =25Ω	N	-	20	30	nS
			P	-	15	26	
t_r	Rise Time	P-Channel $V_{DD}=-15, V_{GS}=-10\text{V}$ I _D =-1A, R _{GEN} =15Ω	N	-	9	20	
			P	-	16	21	
$t_{d(off)}$	Turn-Off Delay Time		N	-	70	102	
			P	-	62	108	
t_f	Fall-Time		N	-	20	81	
			P	-	46	71	

Note 3: Pulse test: $PW \leq 300\mu\text{s}$ duty cycle $\leq 2\%$.

Note 4: Guaranteed by design, not subject to production testing.

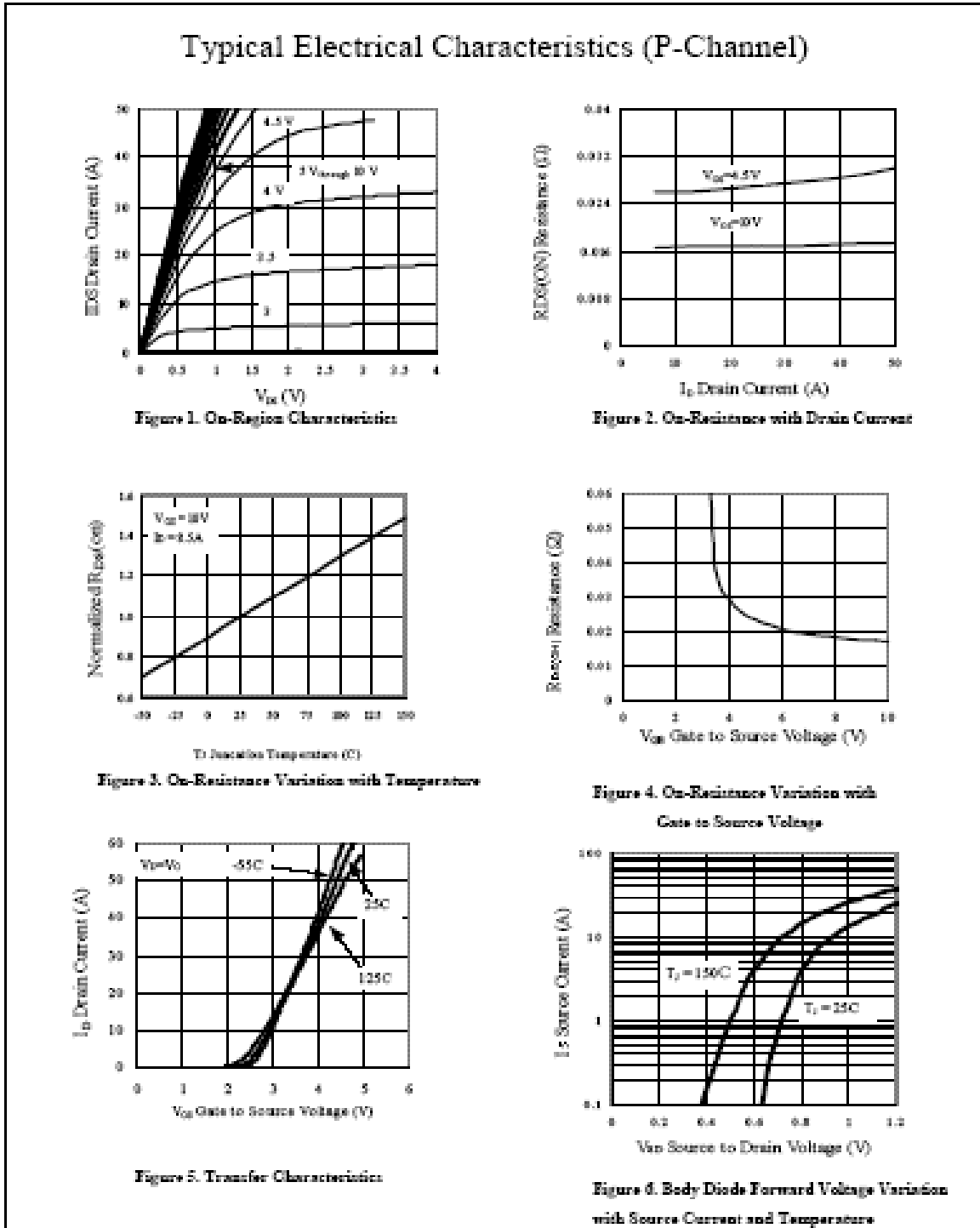
P & N-Channel 30-V (D-S) MOSFET
■ Typical Performance Characteristics

P & N-Channel 30-V (D-S) MOSFET

■ Typical Performance Characteristics (Continued)

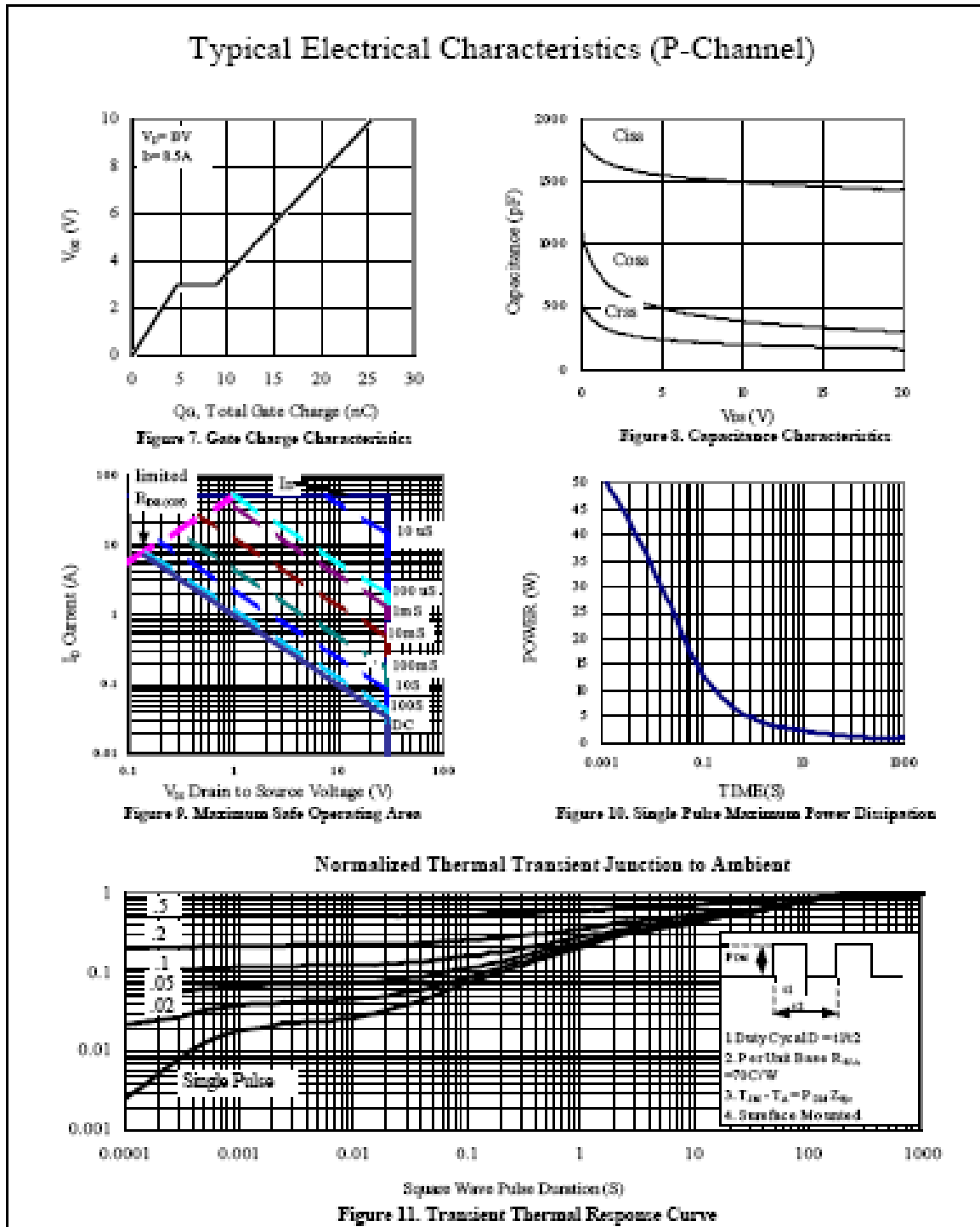

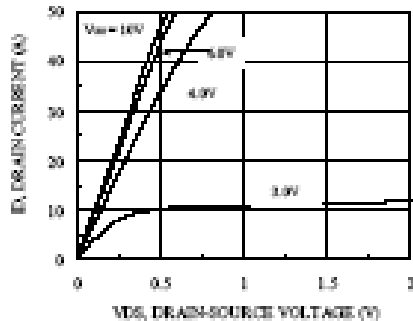
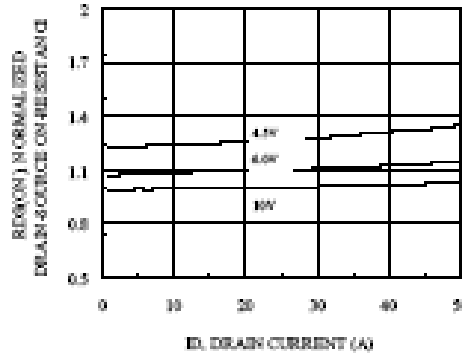
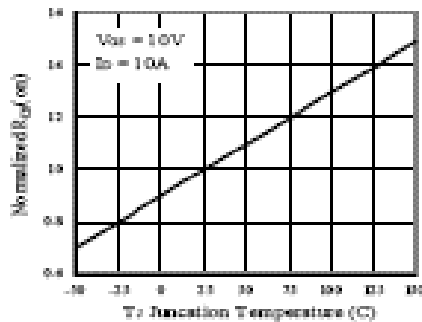
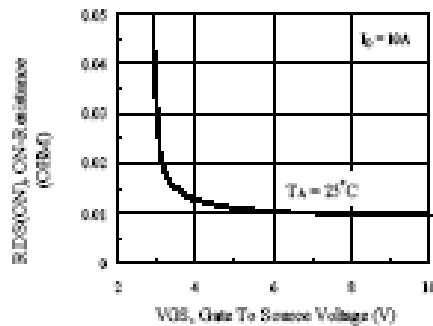
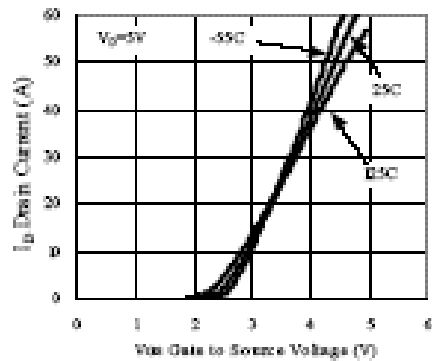
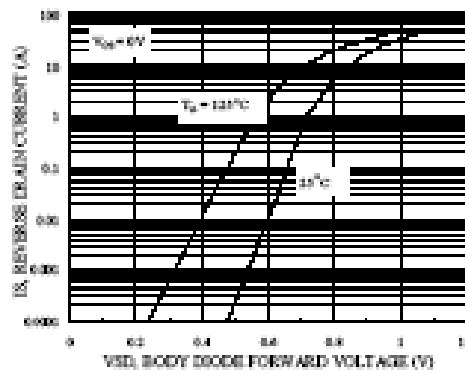
P & N-Channel 30-V (D-S) MOSFET
■ Typical Performance Characteristics (Continued)
Typical Electrical Characteristics (N-Channel)

Figure 1. On-Region Characteristics

Figure 2. On-Resistance with Drain Current

Figure 3. On-Resistance Variation with Temperature

Figure 4. On-Resistance Variation with Gate to Source Voltage

Figure 5. Transfer Characteristics

Figure 6. Body Diode Forward Voltage Variation with Source Current and Temperature

P & N-Channel 30-V (D-S) MOSFET

■ Typical Performance Characteristics (Continued)

Typical Electrical Characteristics (N-Channel)

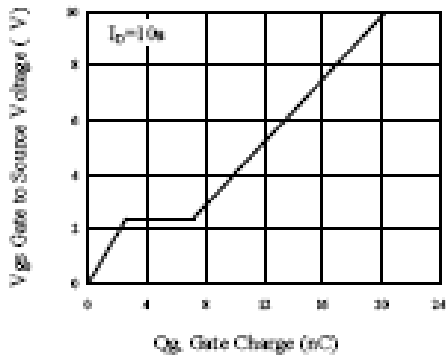

Figure 7. Gate Charge Characteristics

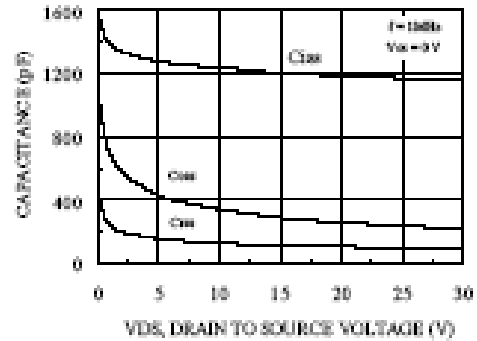

Figure 8. Capacitance Characteristics

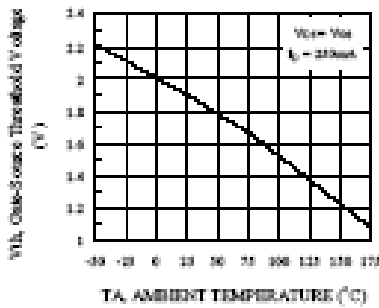

Figure 9. Threshold V_t Ambient Temperature

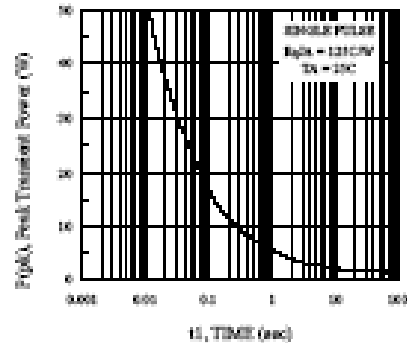

Figure 10. Single Pulse Maximum Power Dissipation

Normalized Thermal Transient Junction to Ambient

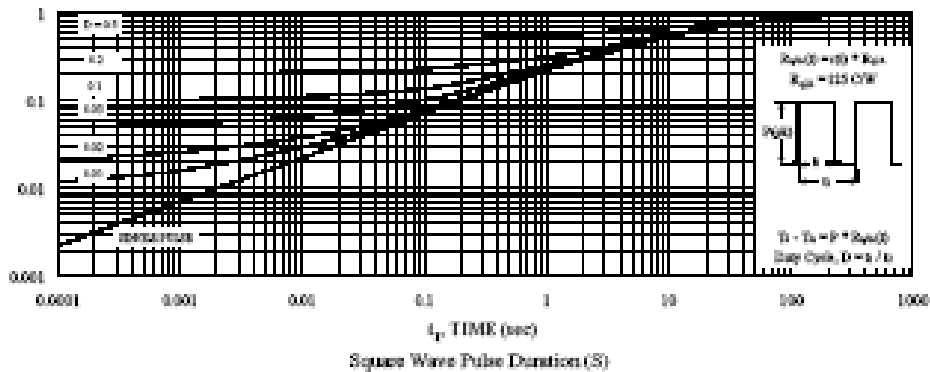
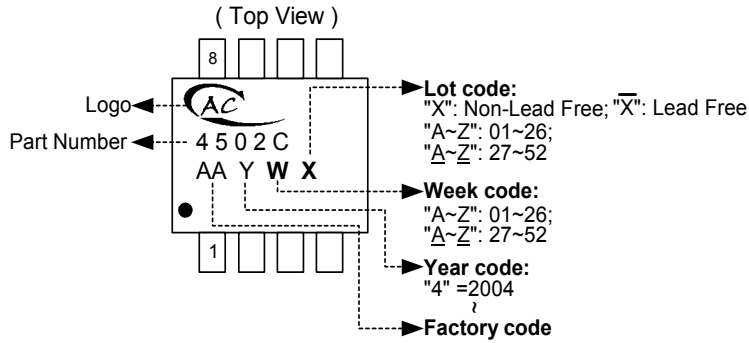

Figure 11. Transient Thermal Response Curve

P & N-Channel 30-V (D-S) MOSFET

■ Marking Information

SOP-8L



■ Package Information

Package Type: SOP-8L

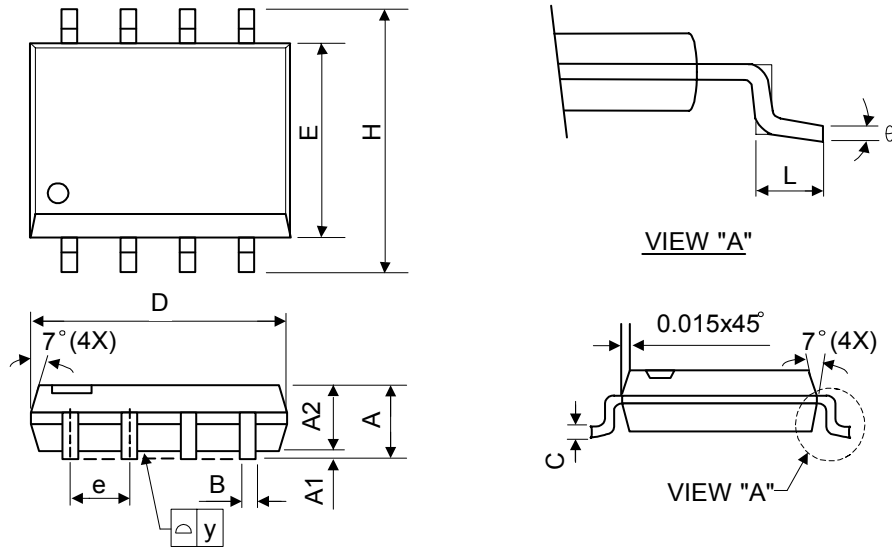

Symbol	Dimensions In Millimeters			Dimensions In Inches		
	Min.	Nom.	Max.	Min.	Nom.	Max.
A	1.40	1.60	1.75	0.055	0.063	0.069
A1	0.10	-	0.25	0.040	-	0.100
A2	1.30	1.45	1.50	0.051	0.057	0.059
B	0.33	0.41	0.51	0.013	0.016	0.020
C	0.19	0.20	0.25	0.0075	0.008	0.010
D	4.80	5.05	5.30	0.189	0.199	0.209
E	3.70	3.90	4.10	0.146	0.154	0.161
e	-	1.27	-	-	0.050	-
H	5.79	5.99	6.20	0.228	0.236	0.244
L	0.38	0.71	1.27	0.015	0.028	0.050
y	-	-	0.10	-	-	0.004
θ	0°	-	8°	0°	-	8°