

**AO3401A**  
**P-Channel Enhancement Mode Field Effect Transistor**
**General Description**

The AO3401A/L uses advanced trench technology to provide excellent  $R_{DS(ON)}$ , low gate charge and operation gate voltages as low as 2.5V. This device is suitable for use as a load switch or other general applications. AO3401A and AO3401AL are electrically identical.  
 -RoHS Compliant  
 -AO3401AL is Halogen Free

**Features**

$V_{DS}$  (V) = -30V  
 $I_D$  = -4.3A ( $V_{GS}$  = -10V)  
 $R_{DS(ON)} < 46m\Omega$  ( $V_{GS}$  = -10V)  
 $R_{DS(ON)} < 55m\Omega$  ( $V_{GS}$  = -4.5V)  
 $R_{DS(ON)} < 80m\Omega$  ( $V_{GS}$  = -2.5V)

*Rg, Ciss, Coss, Crss Tested*

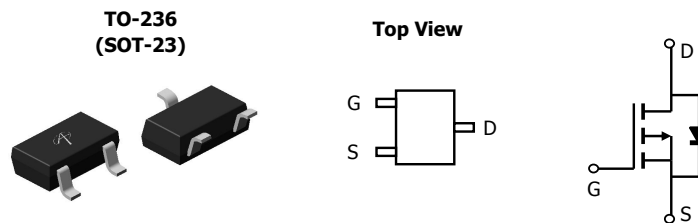
**Absolute Maximum Ratings  $T_A=25^\circ\text{C}$  unless otherwise noted**

Parameter	Symbol	Maximum	Units
Drain-Source Voltage	$V_{DS}$	-30	V
Gate-Source Voltage	$V_{GS}$	$\pm 12$	V
Continuous Drain Current <sup>A,F</sup>	$I_D$	$T_A=25^\circ\text{C}$	-4.3
		$T_A=70^\circ\text{C}$	-3.8
Pulsed Drain Current <sup>B</sup>	$I_{DM}$	-25	A
Power Dissipation <sup>A</sup>	$P_D$	$T_A=25^\circ\text{C}$	1.4
		$T_A=70^\circ\text{C}$	0.9
Junction and Storage Temperature Range	$T_J, T_{STG}$	-55 to 150	$^\circ\text{C}$

**Thermal Characteristics**

Parameter	Symbol	Typ	Max	Units
Maximum Junction-to-Ambient <sup>AF</sup>	$R_{\theta JA}$	65	90	$^\circ\text{C/W}$
Maximum Junction-to-Ambient <sup>A</sup>				
Maximum Junction-to-Lead <sup>C</sup>	$R_{\theta JL}$	43	80	$^\circ\text{C/W}$

Electrical Characteristics ( $T_J=25^\circ\text{C}$  unless otherwise noted)

Symbol	Parameter	Conditions	Min	Typ	Max	Units
<b>STATIC PARAMETERS</b>						
$BV_{DSS}$	Drain-Source Breakdown Voltage	$I_D=-250\mu\text{A}$ , $V_{GS}=0\text{V}$	-30			V
$I_{DSS}$	Zero Gate Voltage Drain Current	$V_{DS}=-30\text{V}$ , $V_{GS}=0\text{V}$ $T_J=55^\circ\text{C}$			-1 -5	$\mu\text{A}$
$I_{GSS}$	Gate-Body leakage current	$V_{DS}=0\text{V}$ , $V_{GS}=\pm 12\text{V}$			$\pm 100$	nA
$V_{GS(th)}$	Gate Threshold Voltage	$V_{DS}=V_{GS}$ , $I_D=-250\mu\text{A}$	-0.6	-1	-1.3	V
$I_{D(ON)}$	On state drain current	$V_{GS}=-4.5\text{V}$ , $V_{DS}=-5\text{V}$	-25			A
$R_{DS(ON)}$	Static Drain-Source On-Resistance	$V_{GS}=-10\text{V}$ , $I_D=-4.3\text{A}$ $T_J=125^\circ\text{C}$		36	44	$\text{m}\Omega$
		$V_{GS}=-4.5\text{V}$ , $I_D=-3.5\text{A}$		44	55	
		$V_{GS}=-2.5\text{V}$ , $I_D=-2.5\text{A}$		62	80	$\text{m}\Omega$
$g_{FS}$	Forward Transconductance	$V_{DS}=-5\text{V}$ , $I_D=-4.3\text{A}$		13		S
$V_{SD}$	Diode Forward Voltage	$I_S=-1\text{A}$ , $V_{GS}=0\text{V}$		-0.75	-1	V
$I_S$	Maximum Body-Diode Continuous Current				-2	A
<b>DYNAMIC PARAMETERS</b>						
$C_{iss}$	Input Capacitance	$V_{GS}=0\text{V}$ , $V_{DS}=-15\text{V}$ , $f=1\text{MHz}$		933	1200	pF
$C_{oss}$	Output Capacitance			108		pF
$C_{rss}$	Reverse Transfer Capacitance			81		pF
$R_g$	Gate resistance	$V_{GS}=0\text{V}$ , $V_{DS}=0\text{V}$ , $f=1\text{MHz}$		6	9	$\Omega$
<b>SWITCHING PARAMETERS</b>						
$Q_g$	Total Gate Charge	$V_{GS}=-4.5\text{V}$ , $V_{DS}=-15\text{V}$ , $I_D=-4.3\text{A}$		9.3	12.2	nC
$Q_{gs}$	Gate Source Charge			1.5		nC
$Q_{gd}$	Gate Drain Charge			3.7		nC
$t_{D(on)}$	Turn-On Delay Time	$V_{GS}=-10\text{V}$ , $V_{DS}=-15\text{V}$ , $R_L=3.5\Omega$ , $R_{GEN}=6\Omega$		5.2		ns
$t_r$	Turn-On Rise Time			6.8		ns
$t_{D(off)}$	Turn-Off Delay Time			42		ns
$t_f$	Turn-Off Fall Time			15		ns
$t_{rr}$	Body Diode Reverse Recovery Time		$I_F=-4.3\text{A}$ , $dI/dt=100\text{A}/\mu\text{s}$		21	28
$Q_{rr}$	Body Diode Reverse Recovery Charge	$I_F=-4.3\text{A}$ , $dI/dt=100\text{A}/\mu\text{s}$		14.3		nC

A: The value of  $R_{\theta JA}$  is measured with the device mounted on  $1\text{in}^2$  FR-4 board with 2oz. Copper, in a still air environment with  $T_A=25^\circ\text{C}$ . The value in any given application depends on the user's specific board design.

B: Repetitive rating, pulse width limited by junction temperature.

C: The  $R_{\theta JA}$  is the sum of the thermal impedance from junction to lead  $R_{\theta JL}$  and lead to ambient.

D: The static characteristics in Figures 1 to 6 are obtained using  $<300\mu\text{s}$  pulses, duty cycle 0.5% max.

E: These tests are performed with the device mounted on  $1\text{in}^2$  FR-4 board with 2oz. Copper, in a still air environment with  $T_A=25^\circ\text{C}$ . The SOA curve provides a single pulse rating.

F: The current rating is based on the  $t \leq 10\text{s}$  thermal resistance rating.

Rev2: Aug.2008

THIS PRODUCT HAS BEEN DESIGNED AND QUALIFIED FOR THE CONSUMER MARKET. APPLICATIONS OR USES AS CRITICAL COMPONENTS IN LIFE SUPPORT DEVICES OR SYSTEMS ARE NOT AUTHORIZED. AOS DOES NOT ASSUME ANY LIABILITY ARISING OUT OF SUCH APPLICATIONS OR USES OF ITS PRODUCTS. AOS RESERVES THE RIGHT TO IMPROVE PRODUCT DESIGN, FUNCTIONS AND RELIABILITY WITHOUT NOTICE.

TYPICAL ELECTRICAL AND THERMAL CHARACTERISTICS

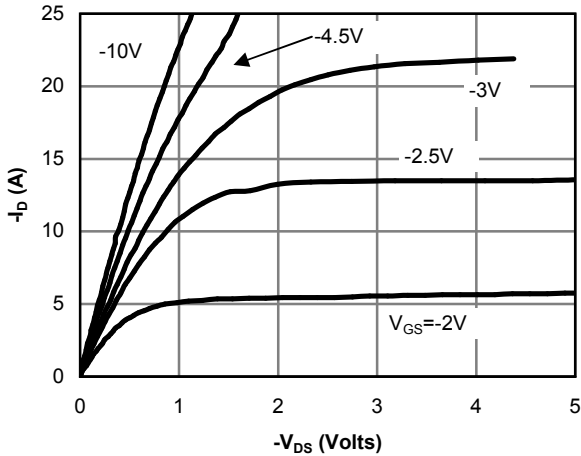

Figure 1: On-Region Characteristics

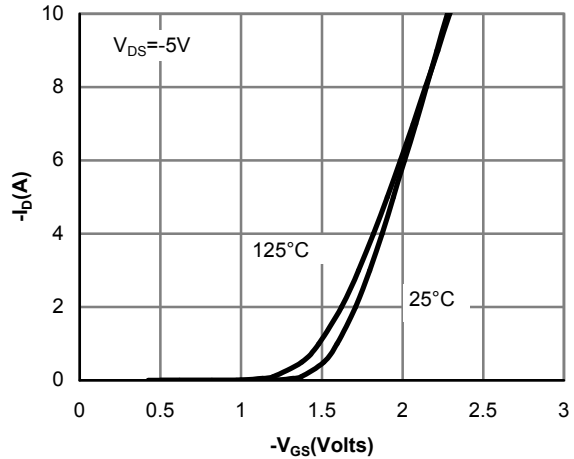

Figure 2: Transfer Characteristics

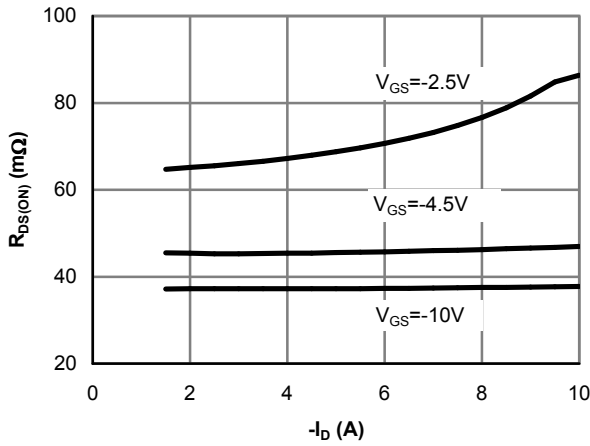

Figure 3: On-Resistance vs. Drain Current and Gate Voltage

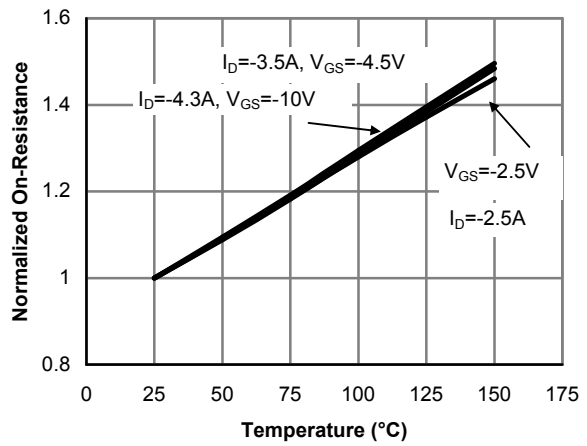

Figure 4: On-Resistance vs. Junction Temperature

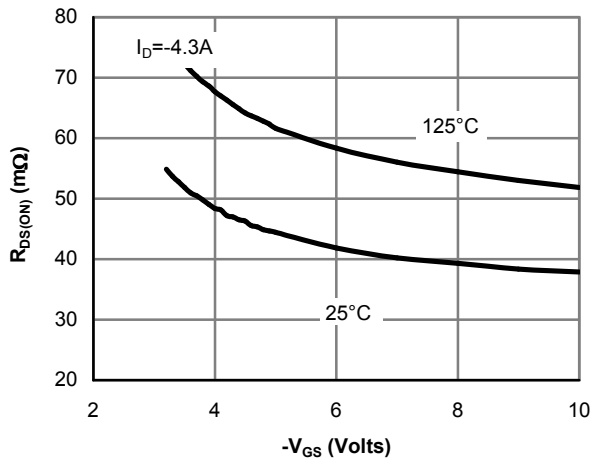

Figure 5: On-Resistance vs. Gate-Source Voltage

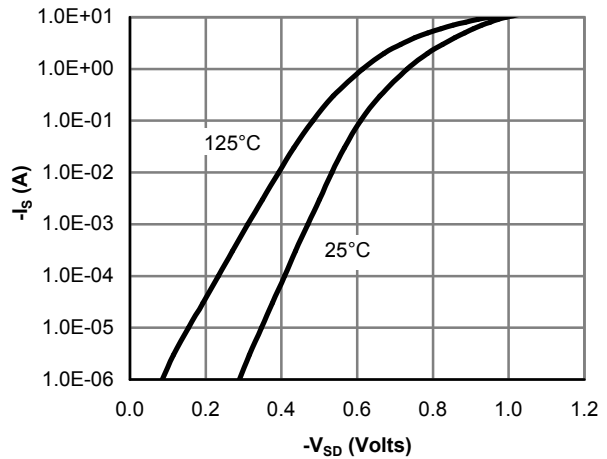

Figure 6: Body-Diode Characteristics

TYPICAL ELECTRICAL AND THERMAL CHARACTERISTICS

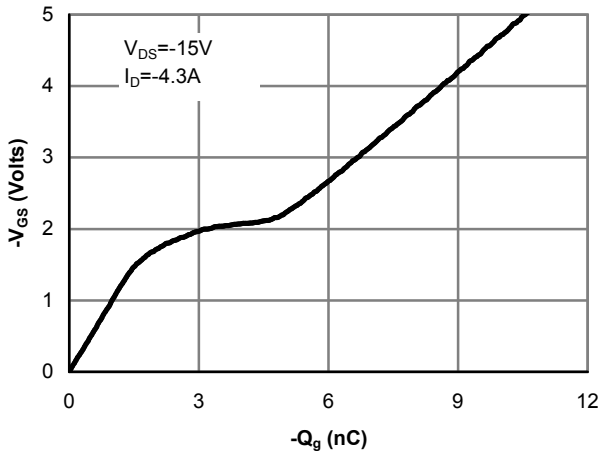

Figure 7: Gate-Charge Characteristics

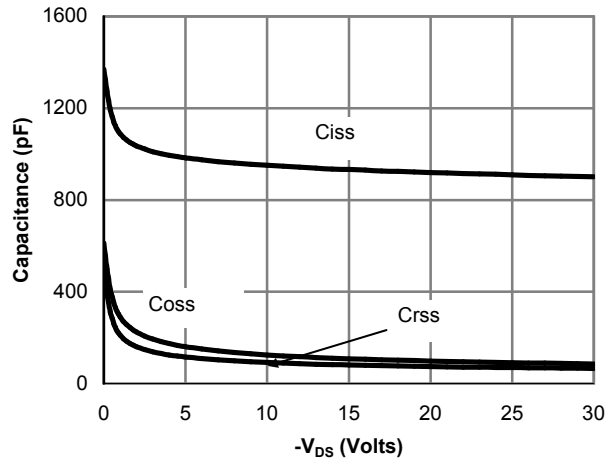

Figure 8: Capacitance Characteristics

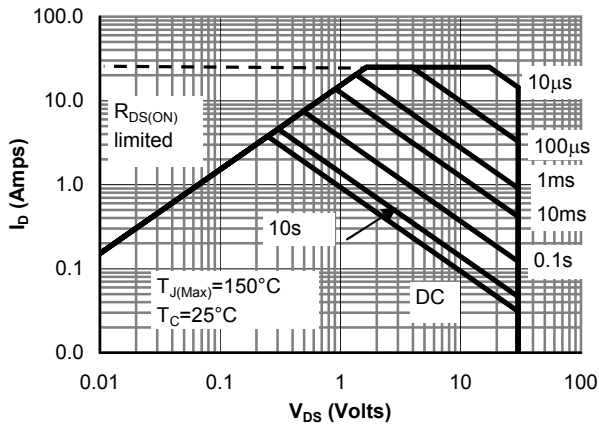

Figure 9: Maximum Forward Biased Safe Operating Area (Note F)

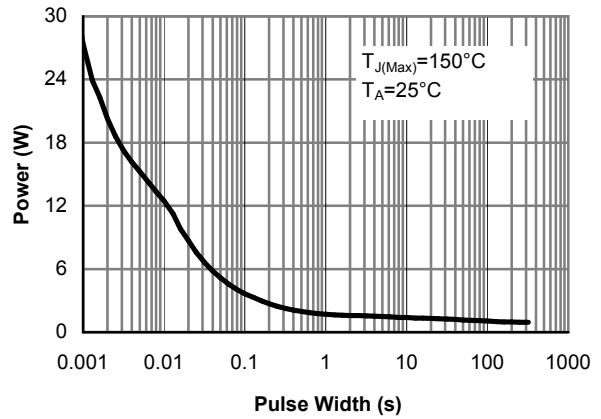

Figure 10: Single Pulse Power Rating Junction-to-Ambient (Note E)

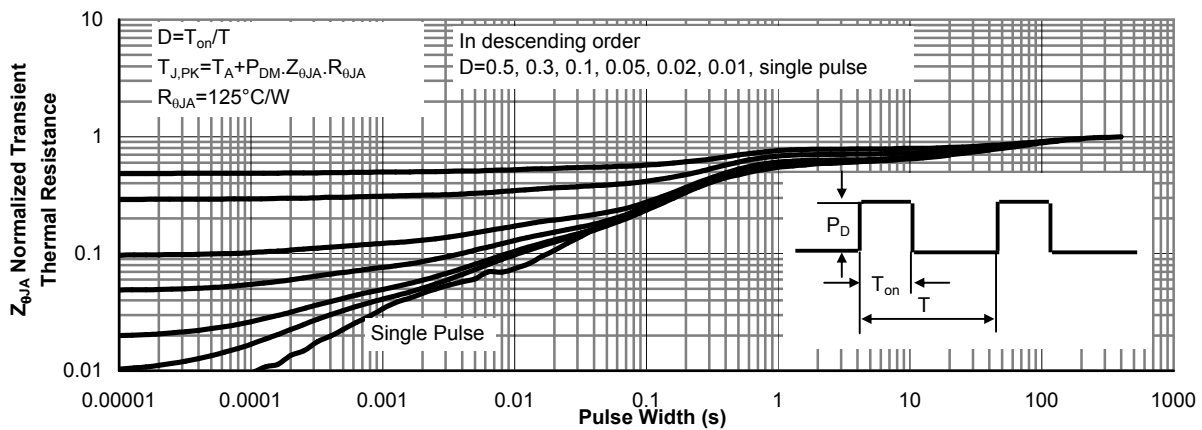
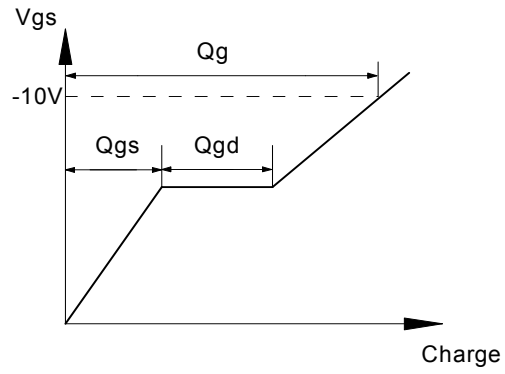
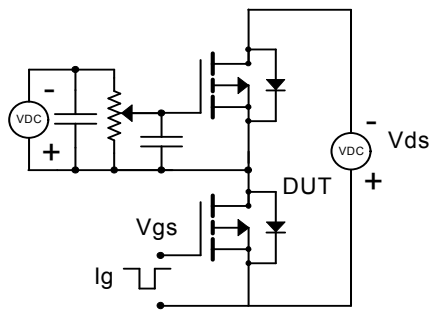
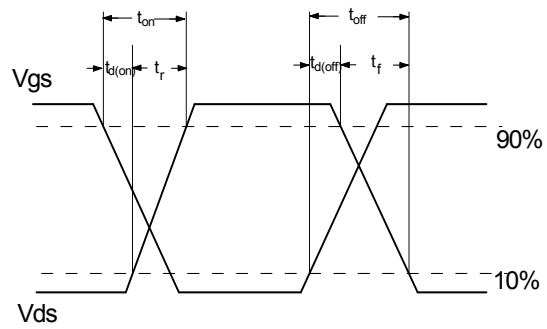
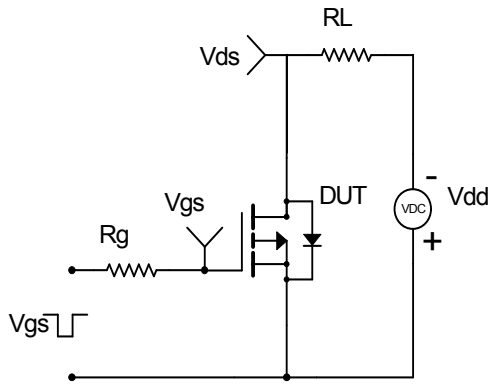

Figure 11: Normalized Maximum Transient Thermal Impedance

Gate Charge Test Circuit & Waveform



Resistive Switching Test Circuit & Waveforms



Diode Recovery Test Circuit & Waveforms

