

## Dual Enhancement Mode MOSFET (N-and P-Channel)

### Features

- N-Channel  
30V/7A,  
 $R_{DS(ON)} = 20m\Omega$  (typ.) @  $V_{GS} = 10V$   
 $R_{DS(ON)} = 27m\Omega$  (typ.) @  $V_{GS} = 4.5V$
- P-Channel  
-30V/-5A,  
 $R_{DS(ON)} = 38m\Omega$  (typ.) @  $V_{GS} = -10V$   
 $R_{DS(ON)} = 46m\Omega$  (typ.) @  $V_{GS} = -4.5V$
- Super High Dense Cell Design
- Reliable and Rugged
- Lead Free Available (RoHS Compliant)

### Applications

- Power Management in Notebook Computer, Portable Equipment and Battery Powered Systems

### Pin Description



Top View of SOP – 8

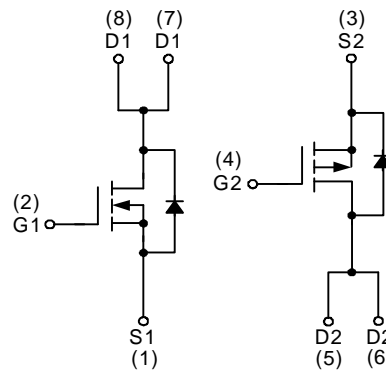

N-Channel MOSFET P-Channel MOSFET

### Ordering and Marking Information

<p>APM4546 <span style="font-family: monospace;">□□-□□□</span></p> <div style="margin-left: 20px;"> <p>└─ Lead Free Code</p> <p>└─ Handling Code</p> <p>└─ Temp. Range</p> <p>└─ Package Code</p> </div>	<p>Package Code K : SOP-8</p> <p>Operating Junction Temp. Range C : -55 to 150 °C</p> <p>Handling Code TU : Tube    TR : Tape &amp; Reel</p> <p>Lead Free Code L : Lead Free Device    Blank : Original Device</p>
<p>APM4546 K : <span style="border: 1px solid black; padding: 2px 5px;">APM4546 XXXXX</span></p>	<p>XXXXX - Date Code</p>

Note: ANPEC lead-free products contain molding compounds/die attach materials and 100% matte tin plate termination finish; which are fully compliant with RoHS and compatible with both SnPb and lead-free soldering operations. ANPEC lead-free products meet or exceed the lead-free requirements of IPC/JEDEC J STD-020C for MSL classification at lead-free peak reflow temperature.

ANPEC reserves the right to make changes to improve reliability or manufacturability without notice, and advise customers to obtain the latest version of relevant information to verify before placing orders.

**Absolute Maximum Ratings** ( $T_A = 25^\circ\text{C}$  unless otherwise noted)

Symbol	Parameter	N Channel	P Channel	Unit
$V_{DSS}$	Drain-Source Voltage	30	-30	V
$V_{GSS}$	Gate-Source Voltage	$\pm 20$	$\pm 20$	
$I_D^*$	Continuous Drain Current	7	-5	A
$I_{DM}^*$	Pulsed Drain Current			
$I_S^*$	Diode Continuous Forward Current	2	-2	A
$T_J$	Maximum Junction Temperature	150		$^\circ\text{C}$
$T_{STG}$	Storage Temperature Range	-55 to 150		
$P_D^*$	Power Dissipation	$T_A=25^\circ\text{C}$		W
		$T_A=100^\circ\text{C}$		
$R_{\theta JA}^*$	Thermal Resistance-Junction to Ambient	62.5		$^\circ\text{C}/\text{W}$

Note:

\*Surface Mounted on  $1\text{in}^2$  pad area,  $t \leq 10\text{sec}$ .

**Electrical Characteristics** ( $T_A = 25^\circ\text{C}$  unless otherwise noted)

Symbol	Parameter	Test Condition	APM4546K			Unit	
			Min.	Typ.	Max.		
<b>Static Characteristics</b>							
$BV_{DSS}$	Drain-Source Breakdown Voltage	$V_{GS}=0\text{V}, I_{DS}=250\mu\text{A}$	N-Ch	30		V	
		$V_{GS}=0\text{V}, I_{DS}=-250\mu\text{A}$	P-Ch	-30			
$I_{DSS}$	Zero Gate Voltage Drain Current	$V_{DS}=24\text{V}, V_{GS}=0\text{V}$ $T_J=85^\circ\text{C}$	N-Ch		1	$\mu\text{A}$	
			P-Ch		-1		
		$V_{DS}=-24\text{V}, V_{GS}=0\text{V}$ $T_J=85^\circ\text{C}$	N-Ch		30		
			P-Ch		-30		
$V_{GS(th)}$	Gate Threshold Voltage	$V_{DS}=V_{GS}, I_{DS}=250\mu\text{A}$	N-Ch	0.8	1.5	2	V
		$V_{DS}=V_{GS}, I_{DS}=-250\mu\text{A}$	P-Ch	-0.8	-1.5	-2	
$I_{GSS}$	Gate Leakage Current	$V_{GS}=\pm 20\text{V}, V_{DS}=0\text{V}$	N-Ch			$\pm 100$	nA
		$V_{GS}=\pm 20\text{V}, V_{DS}=0\text{V}$	P-Ch			$\pm 100$	
$R_{DS(ON)}^a$	Drain-Source On-State Resistance	$V_{GS}=10\text{V}, I_{DS}=7\text{A}$	N-Ch		20	26	m $\Omega$
		$V_{GS}=-10\text{V}, I_{DS}=-5\text{A}$	P-Ch		38	50	
		$V_{GS}=4.5\text{V}, I_{DS}=5\text{A}$	N-Ch		27	36	
		$V_{GS}=-4.5\text{V}, I_{DS}=-4\text{A}$	P-Ch		46	60	

## Electrical Characteristics (Cont.) (T<sub>A</sub> = 25°C unless otherwise noted)

Symbol	Parameter	Test Condition	APM4546K			Unit	
			Min.	Typ.	Max.		
<b>Diode Characteristics</b>							
V <sub>SD</sub> <sup>a</sup>	Diode Forward Voltage	I <sub>SD</sub> =2A, V <sub>GS</sub> =0V	N-Ch		0.8	1.3	V
		I <sub>SD</sub> =-2A, V <sub>GS</sub> =0V	P-Ch		-0.8	-1.3	
<b>Dynamic Characteristics<sup>b</sup></b>							
R <sub>G</sub>	Gate Resistance	V <sub>GS</sub> =0V, V <sub>DS</sub> =0V, F=1MHz	N-Ch		2		Ω
			P-Ch		10		
C <sub>iss</sub>	Input Capacitance	N-Channel V <sub>GS</sub> =0V, V <sub>DS</sub> =15V, Frequency=1.0MHz	N-Ch		790		pF
			P-Ch		900		
C <sub>oss</sub>	Output Capacitance		N-Ch		130		
			P-Ch		140		
C <sub>rss</sub>	Reverse Transfer Capacitance	V <sub>GS</sub> =0V, V <sub>DS</sub> =-15V, Frequency=1.0MHz	N-Ch		80		
			P-Ch		75		
t <sub>d(ON)</sub>	Turn-on Delay Time	N-Channel V <sub>DD</sub> =15V, R <sub>L</sub> =15Ω, I <sub>DS</sub> =1A, V <sub>GEN</sub> =10V, R <sub>G</sub> =6Ω	N-Ch		7	14	ns
			P-Ch		7	14	
T <sub>r</sub>	Turn-on Rise Time	P-Channel V <sub>DD</sub> =-15V, R <sub>L</sub> =15Ω, I <sub>DS</sub> =-1A, V <sub>GEN</sub> =-10V, R <sub>G</sub> =6Ω	N-Ch		9	17	
			P-Ch		12	17	
t <sub>d(OFF)</sub>	Turn-off Delay Time	N-Channel V <sub>DD</sub> =15V, R <sub>L</sub> =15Ω, I <sub>DS</sub> =1A, V <sub>GEN</sub> =10V, R <sub>G</sub> =6Ω	N-Ch		27	36	
			P-Ch		42	56	
T <sub>f</sub>	Turn-off Fall Time	P-Channel V <sub>DD</sub> =-15V, R <sub>L</sub> =15Ω, I <sub>DS</sub> =-1A, V <sub>GEN</sub> =-10V, R <sub>G</sub> =6Ω	N-Ch		6	12	
			P-Ch		19	26	
Q <sub>rr</sub>	Reverse Recovery Charge	N-Channel I <sub>SD</sub> =7A, dI <sub>SD</sub> /dt =100A/μs P-Channel I <sub>SD</sub> =-5A, dI <sub>SD</sub> /dt =100A/μs	N-Ch		10		nC
			P-Ch		9		
<b>Gate Charge Characteristics<sup>b</sup></b>							
Q <sub>g</sub>	Total Gate Charge	N-Channel V <sub>DS</sub> =15V, V <sub>GS</sub> =10V, I <sub>DS</sub> =7A	N-Ch		18.1	24	nC
			P-Ch		18.2	24	
Q <sub>gs</sub>	Gate-Source Charge	P-Channel V <sub>DS</sub> =-15V, V <sub>GS</sub> =-10V, I <sub>DS</sub> =-5A	N-Ch		1.7		
			P-Ch		2.3		
Q <sub>gd</sub>	Gate-Drain Charge		N-Ch		2.2		
			P-Ch		1.6		

Notes:

a : Pulse test ; pulse width ≤ 300μs, duty cycle ≤ 2%.

b : Guaranteed by design, not subject to production testing.

## Typical Characteristics

### N-Channel

Power Dissipation

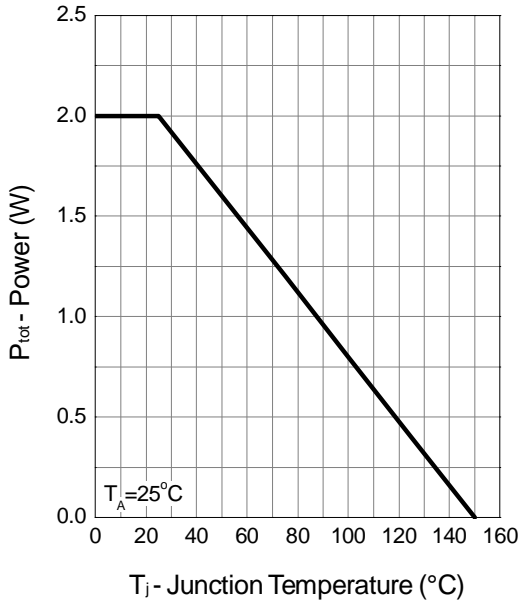

Drain Current

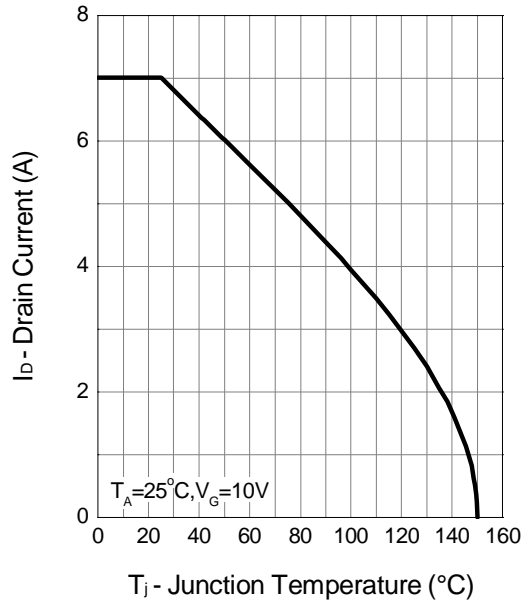

Safe Operation Area

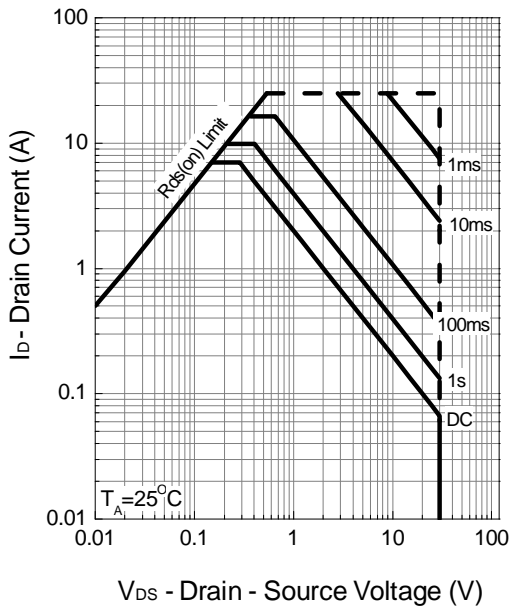

Thermal Transient Impedance

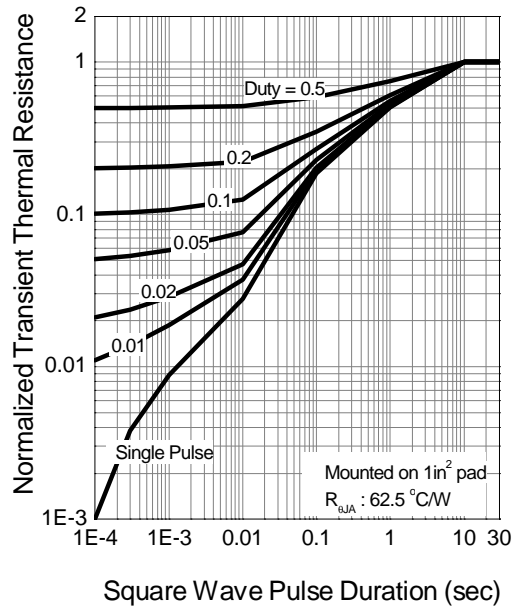

## Typical Characteristics (Cont.)

N-Channel

Output Characteristics

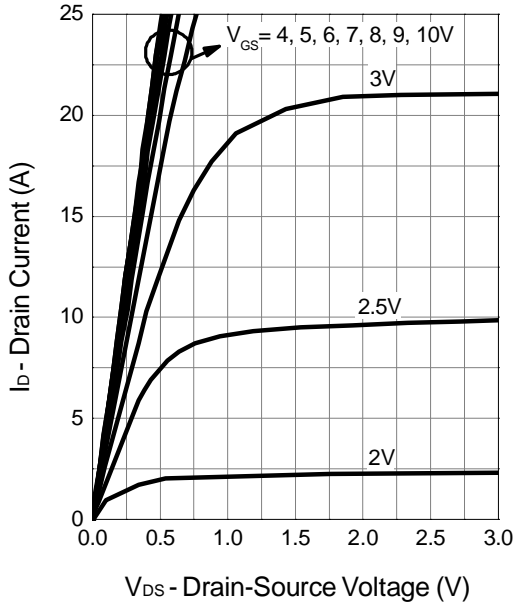

Drain-Source On Resistance

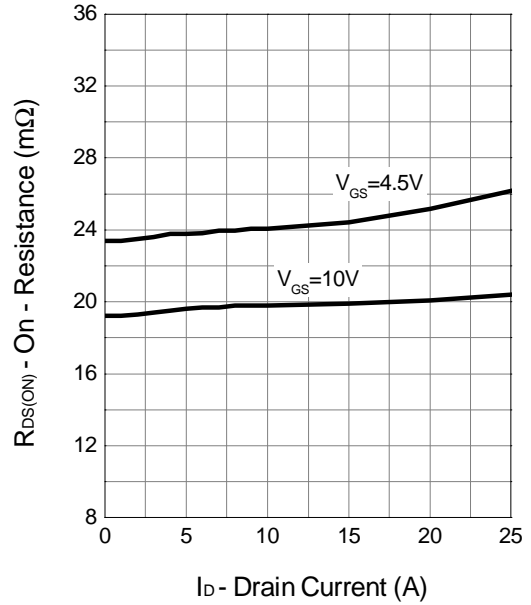

Transfer Characteristics

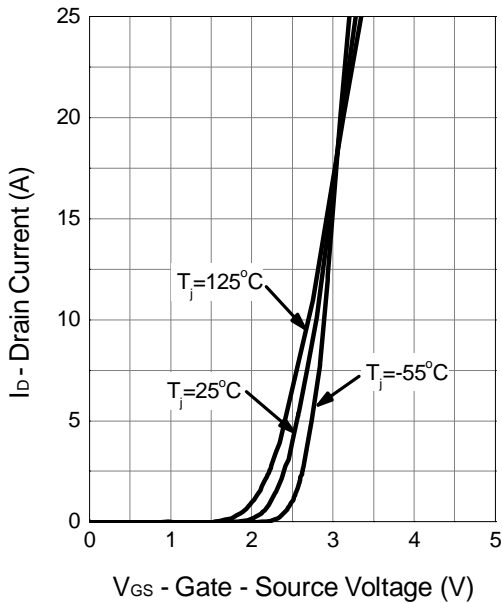

Gate Threshold Voltage

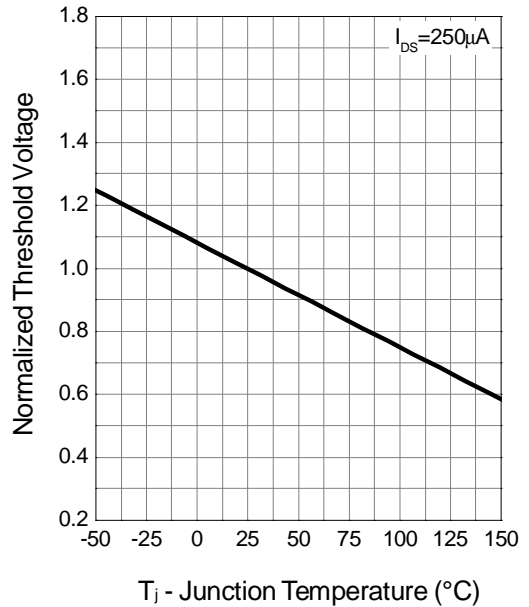

## Typical Characteristics (Cont.)

### N-Channel

Drain-Source On Resistance

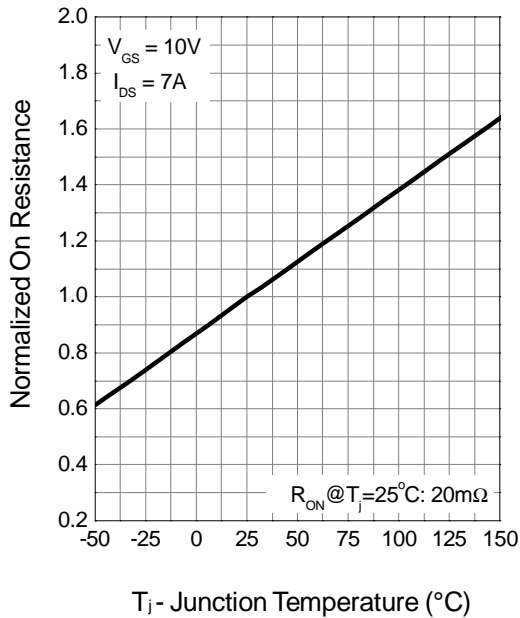

Source-Drain Diode Forward

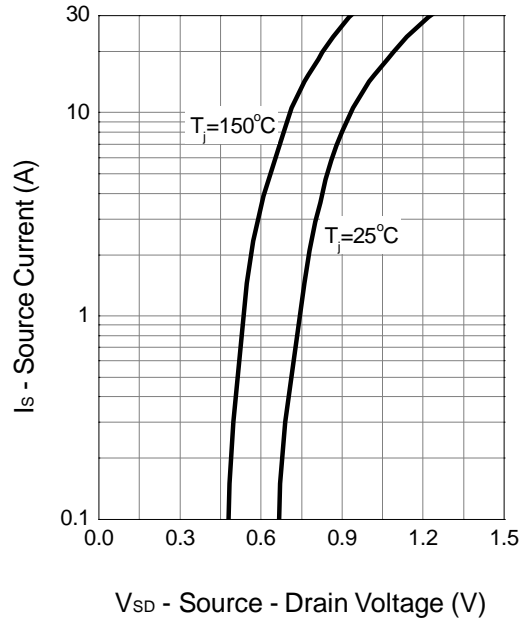

Capacitance

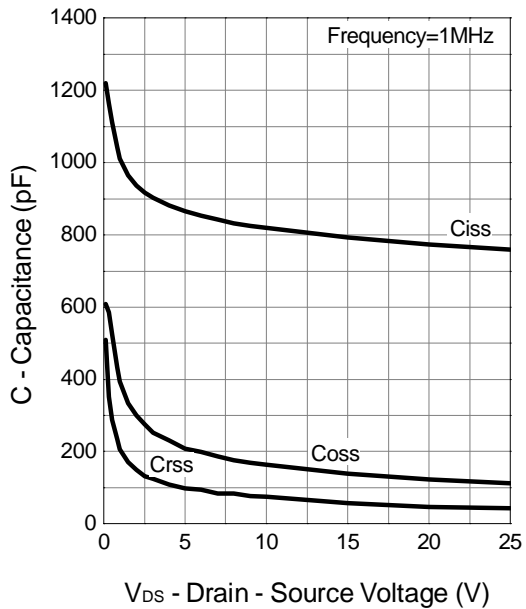

Gate Charge

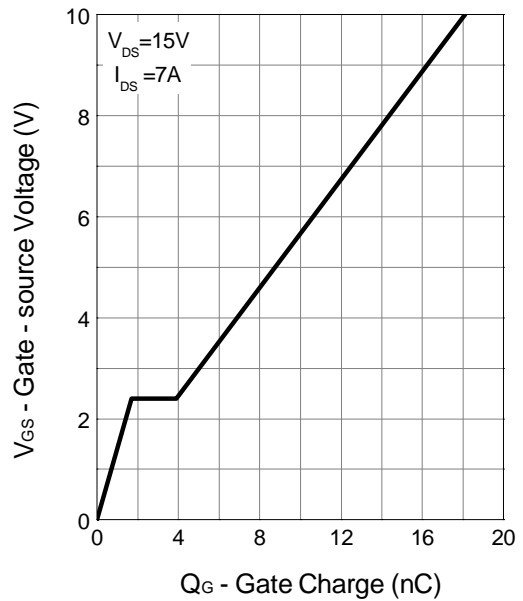

## Typical Characteristics (Cont.)

### P-Channel

Power Dissipation

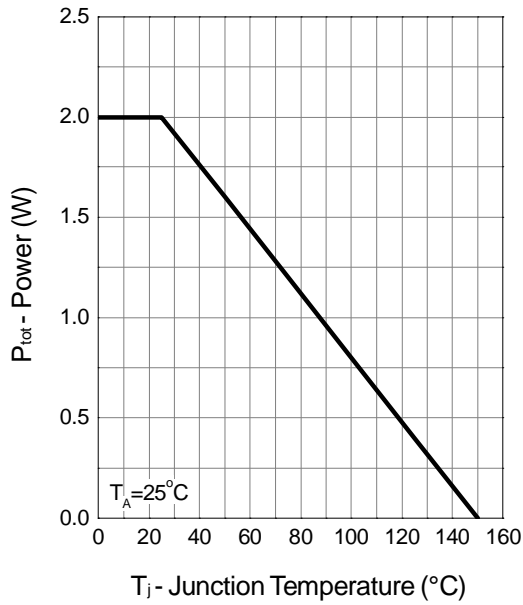

Drain Current

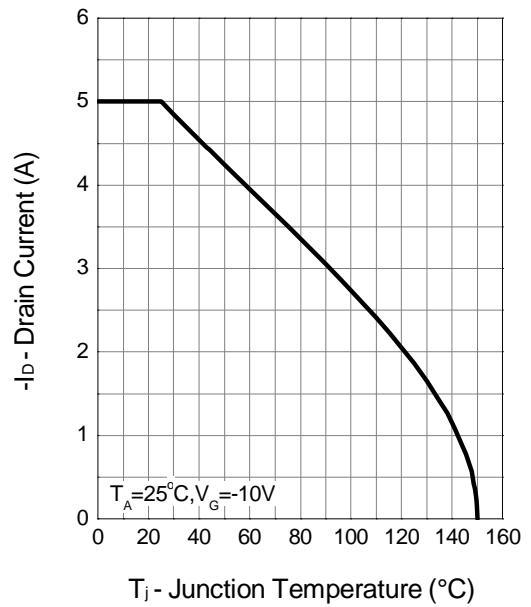

Safe Operation Area

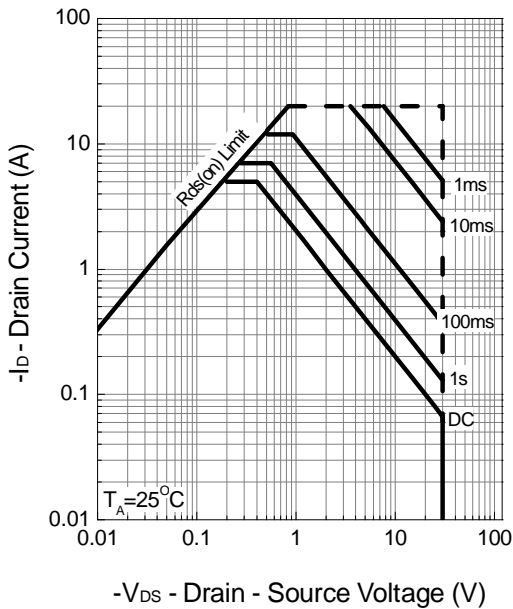

Thermal Transient Impedance

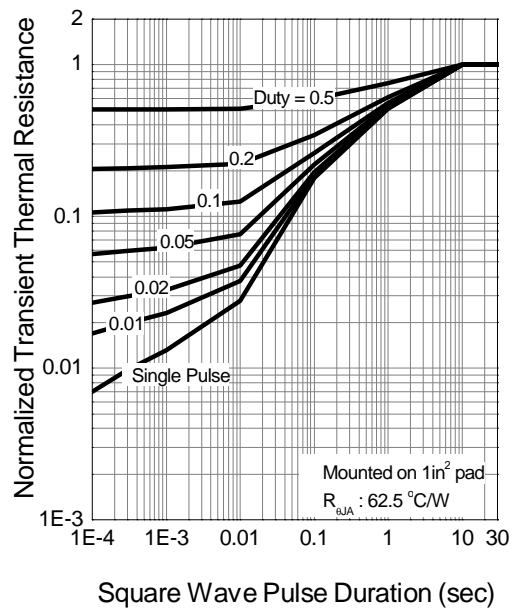

## Typical Characteristics (Cont.)

P-Channel

Output Characteristics

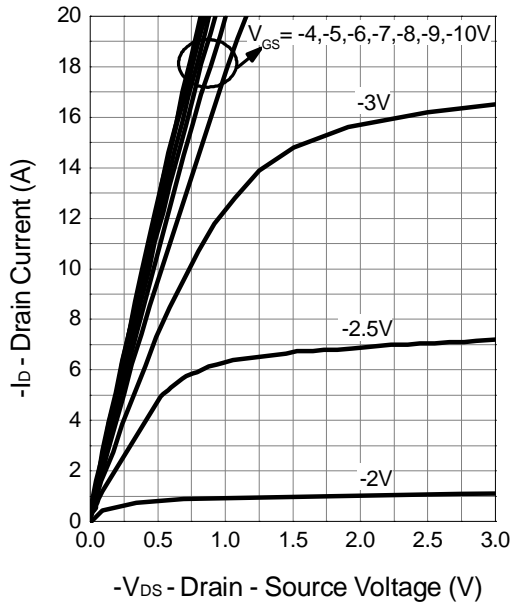

Drain-Source On Resistance

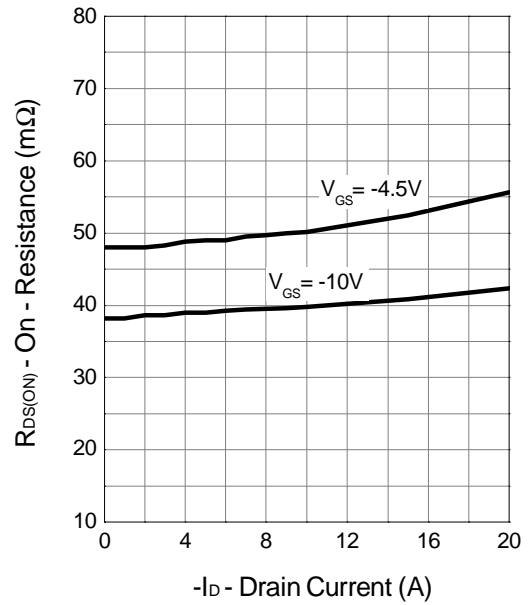

Transfer Characteristics

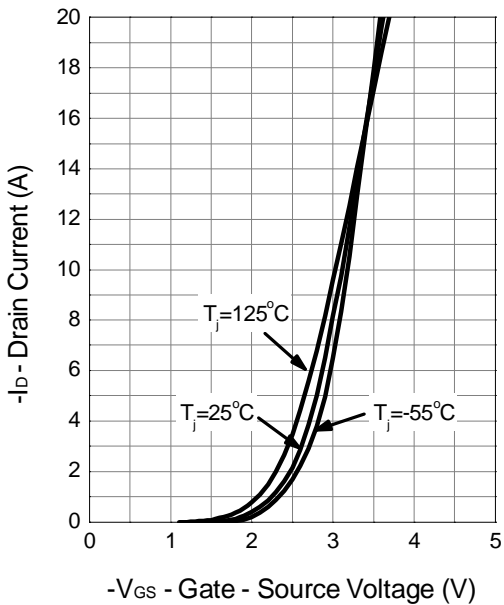

Gate Threshold Voltage

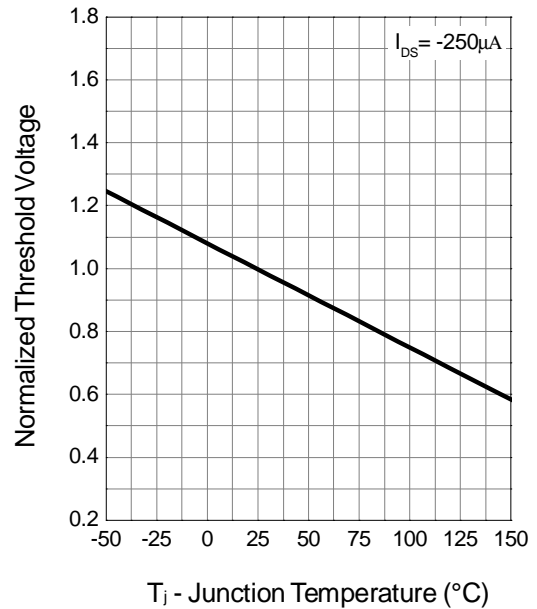



## Typical Characteristics (Cont.)

### P-Channel

Drain-Source On Resistance

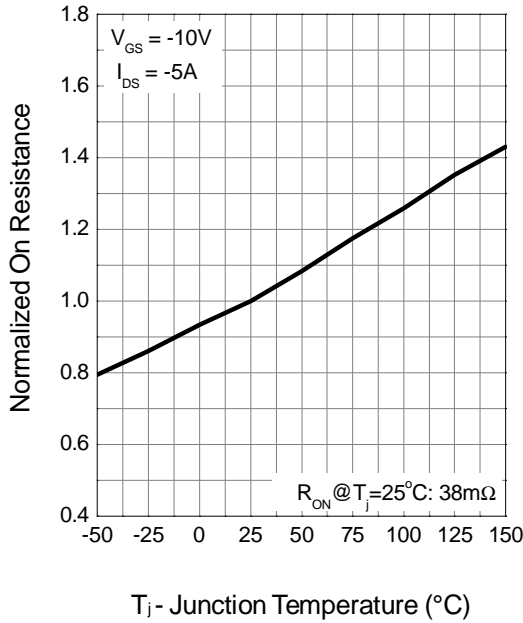

Source-Drain Diode Forward

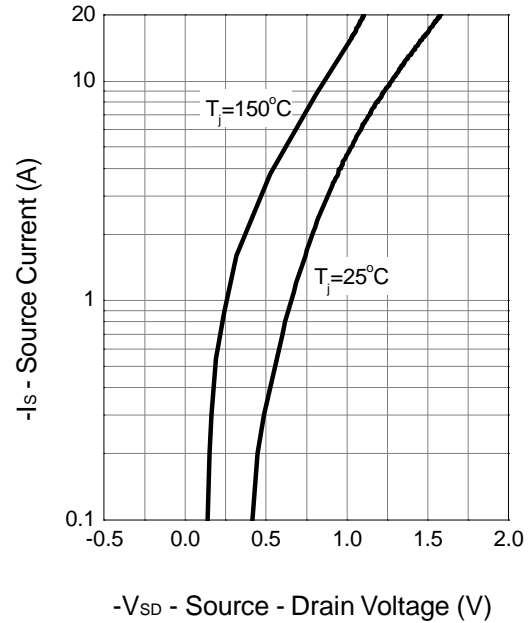

Capacitance

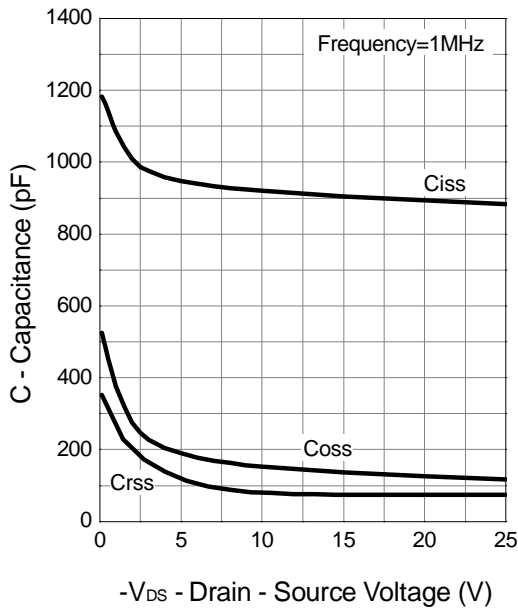

Gate Charge

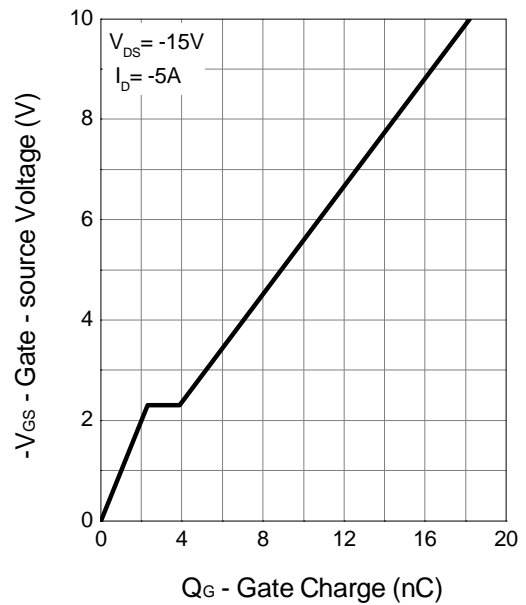

### Packaging Information

SOP-8 pin ( Reference JEDEC Registration MS-012)

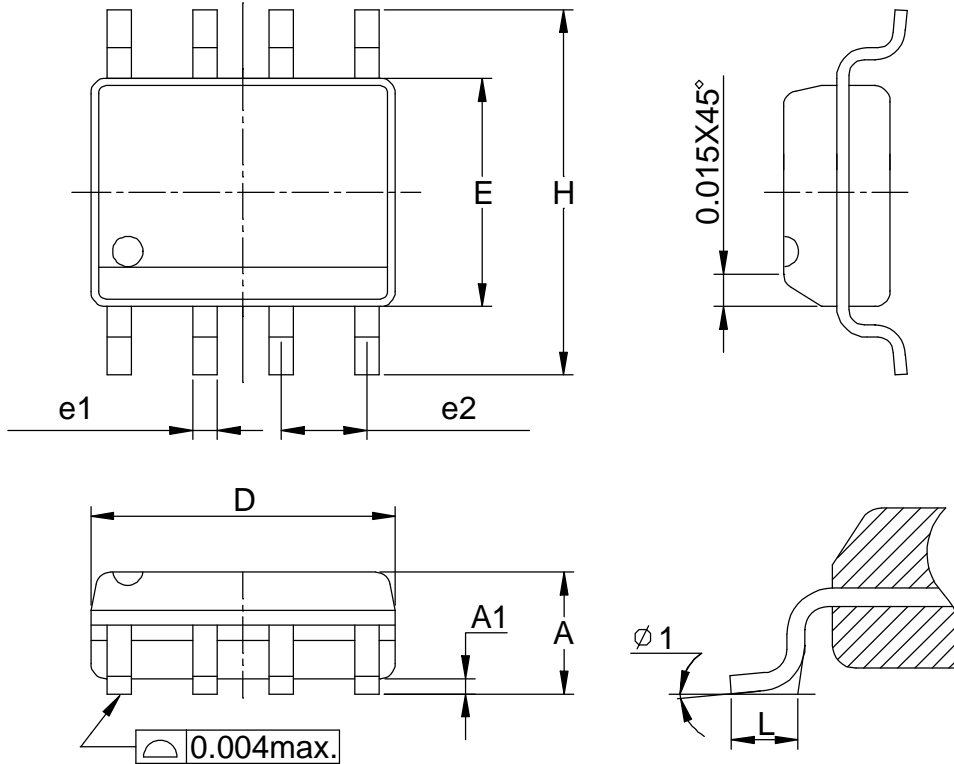

Dim	Millimeters		Inches	
	Min.	Max.	Min.	Max.
A	1.35	1.75	0.053	0.069
A1	0.10	0.25	0.004	0.010
D	4.80	5.00	0.189	0.197
E	3.80	4.00	0.150	0.157
H	5.80	6.20	0.228	0.244
L	0.40	1.27	0.016	0.050
e1	0.33	0.51	0.013	0.020
e2	1.27BSC		0.50BSC	
φ 1	8°		8°	

## Physical Specifications

Terminal Material	Solder-Plated Copper (Solder Material : 90/10 or 63/37 SnPb), 100%Sn
Lead Solderability	Meets EIA Specification RSI86-91, ANSI/J-STD-002 Category 3.

### Reflow Condition (IR/Convection or VPR Reflow)

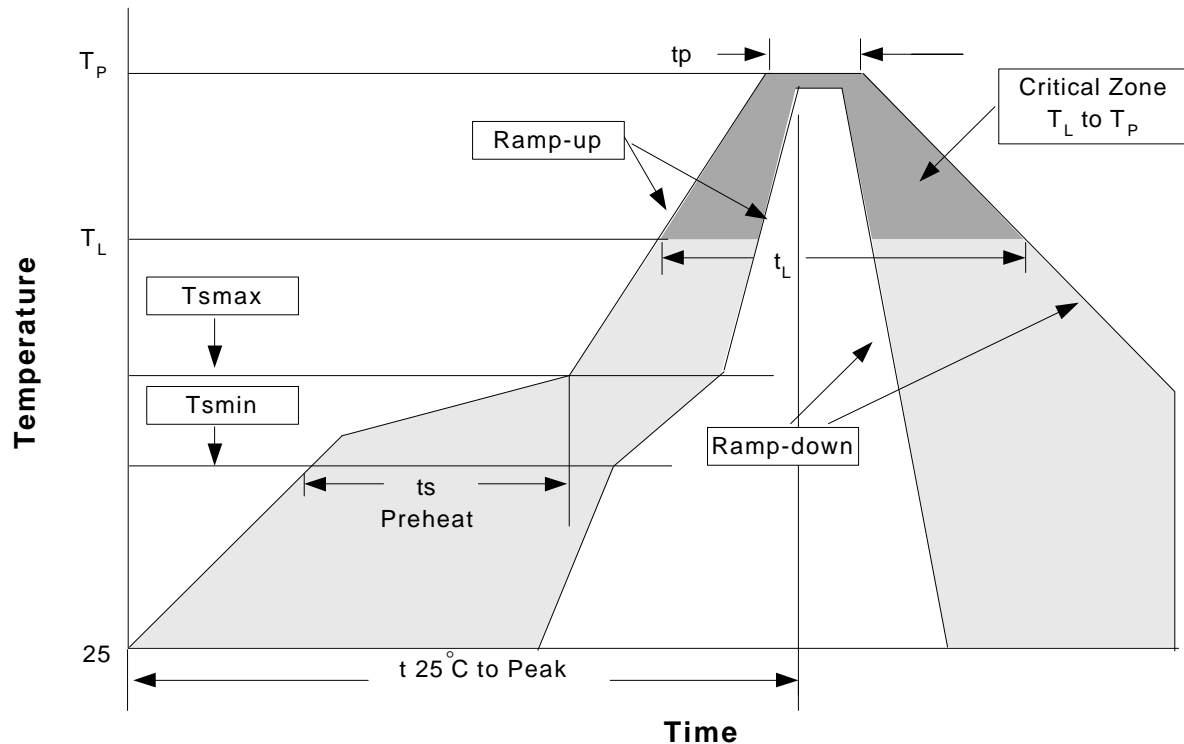

### Classification Reflow Profiles

Profile Feature	Sn-Pb Eutectic Assembly	Pb-Free Assembly
Average ramp-up rate ( $T_L$ to $T_P$ )	3°C/second max.	3°C/second max.
Preheat		
- Temperature Min ( $T_{smin}$ )	100°C	150°C
- Temperature Max ( $T_{smax}$ )	150°C	200°C
- Time (min to max) ( $t_s$ )	60-120 seconds	60-180 seconds
Time maintained above:		
- Temperature ( $T_L$ )	183°C	217°C
- Time ( $t_L$ )	60-150 seconds	60-150 seconds
Peak/Classification Temperature ( $T_p$ )	See table 1	See table 2
Time within 5°C of actual Peak Temperature ( $t_p$ )	10-30 seconds	20-40 seconds
Ramp-down Rate	6°C/second max.	6°C/second max.
Time 25°C to Peak Temperature	6 minutes max.	8 minutes max.

Notes: All temperatures refer to topside of the package .Measured on the body surface.

## Classification Reflow Profiles(Cont.)

Table 1. SnPb Eutectic Process – Package Peak Reflow Temperatures

Package Thickness	Volume mm <sup>3</sup> <350	Volume mm <sup>3</sup> ≥350
<2.5 mm	240 +0/-5°C	225 +0/-5°C
≥2.5 mm	225 +0/-5°C	225 +0/-5°C

Table 2. Pb-free Process – Package Classification Reflow Temperatures

Package Thickness	Volume mm <sup>3</sup> <350	Volume mm <sup>3</sup> 350-2000	Volume mm <sup>3</sup> >2000
<1.6 mm	260 +0°C*	260 +0°C*	260 +0°C*
1.6 mm – 2.5 mm	260 +0°C*	250 +0°C*	245 +0°C*
≥2.5 mm	250 +0°C*	245 +0°C*	245 +0°C*

\*Tolerance: The device manufacturer/supplier **shall** assure process compatibility up to and including the stated classification temperature (this means Peak reflow temperature +0°C. For example 260°C+0°C) at the rated MSL level.

## Reliability Test Program

Test item	Method	Description
SOLDERABILITY	MIL-STD-883D-2003	245°C, 5 SEC
HOLT	MIL-STD 883D-1005.7	1000 Hrs Bias @ 125°C
PCT	JESD-22-B, A102	168 Hrs, 100% RH, 121°C
TST	MIL-STD 883D-1011.9	-65°C ~ 150°C, 200 Cycles

## Carrier Tape & Reel Dimensions

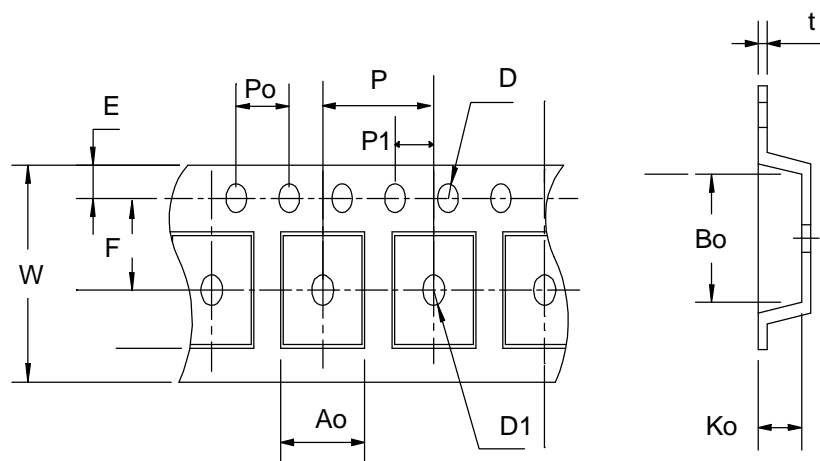

Carrier Tape & Reel Dimensions(Cont.)

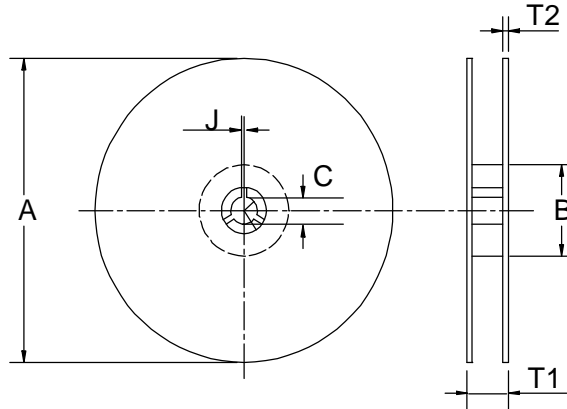

Application	A	B	C	J	T1	T2	W	P	E
SOP-8	330±1	62 ± 1.5	12.75 + 0.1 5	2 + 0.5	12.4 +0.2	2± 0.2	12 + 0.3 - 0.1	8± 0.1	1.75± 0.1
	F	D	D1	Po	P1	Ao	Bo	Ko	t
	5.5 ± 0.1	1.55±0.1	1.55+ 0.25	4.0 ± 0.1	2.0 ± 0.1	6.4 ± 0.1	5.2± 0.1	2.1± 0.1	0.3±0.013

(mm)

Cover Tape Dimensions

Application	Carrier Width	Cover Tape Width	Devices Per Reel
SOP- 8	12	9.3	2500

Customer Service

**Anpec Electronics Corp.**

Head Office :

No.6, Dusing 1st Road, SBIP,

Hsin-Chu, Taiwan, R.O.C.

Tel : 886-3-5642000

Fax : 886-3-5642050

Taipei Branch :

7F, No. 137, Lane 235, Pac Chiao Rd.,

Hsin Tien City, Taipei Hsien, Taiwan, R. O. C.

Tel : 886-2-89191368

Fax : 886-2-89191369