

BUB323Z

NPN Silicon Power Darlington

High Voltage Autoprotected D²PAK for Surface Mount

The BUB323Z is a planar, monolithic, high-voltage power Darlington with a built-in active zener clamping circuit. This device is specifically designed for unclamped, inductive applications such as Electronic Ignition, Switching Regulators and Motor Control.

Features

- Integrated High-Voltage Active Clamp
- Tight Clamping Voltage Window (350 V to 450 V) Guaranteed Over the -40°C to +125°C Temperature Range
- Clamping Energy Capability 100% Tested in a Live Ignition Circuit
- High DC Current Gain/Low Saturation Voltages Specified Over Full Temperature Range
- Design Guarantees Operation in SOA at All Times
- Pb-Free Packages are Available

MAXIMUM RATINGS

| Rating | Symbol | Value | Unit |
|--|-------------------|----------------|-----------|
| Collector-Emitter Sustaining Voltage | V_{CEO} | 350 | Vdc |
| Collector-Emitter Voltage | V_{EBO} | 6.0 | Vdc |
| Collector Current – Continuous – Peak | I_C I_{CM} | 10 20 | Adc |
| Base Current – Continuous – Peak | I_B I_{BM} | 3.0 6.0 | Adc |
| Total Power Dissipation @ $T_C = 25^\circ\text{C}$ Derate above 25°C | P_D | 150 1.0 | W W/°C |
| Operating and Storage Junction Temperature Range | T_J, T_{stg} | -65 to +175 | °C |

THERMAL CHARACTERISTICS

| Characteristic | Symbol | Max | Unit |
|---|-----------------|------|------|
| Thermal Resistance, Junction-to-Case | $R_{\theta JC}$ | 1.0 | °C/W |
| Thermal Resistance, Junction-to-Ambient | $R_{\theta JA}$ | 62.5 | °C/W |
| Maximum Lead Temperature for Soldering Purposes, 1/8 in from Case for 5 Seconds | T_L | 260 | °C |

Maximum ratings are those values beyond which device damage can occur. Maximum ratings applied to the device are individual stress limit values (not normal operating conditions) and are not valid simultaneously. If these limits are exceeded, device functional operation is not implied, damage may occur and reliability may be affected.



ON Semiconductor®

<http://onsemi.com>

**AUTOPROTECTED
DARLINGTON
10 AMPERES
360-450 VOLTS CLAMP
150 WATTS**

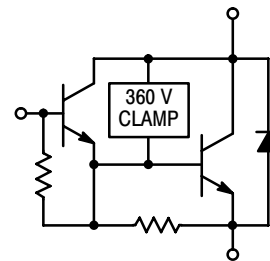

MARKING DIAGRAM

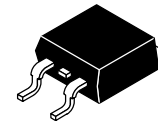

**D²PAK
CASE 418B
STYLE 1**

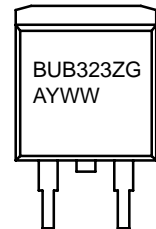

BUB323Z = Specific Device Code
A = Assembly Location
Y = Year
WW = Work Week
G = Pb-Free Package

ORDERING INFORMATION

See detailed ordering and shipping information in the package dimensions section on page 6 of this data sheet.

BUB323Z

ELECTRICAL CHARACTERISTICS ($T_C = 25^\circ\text{C}$ unless otherwise noted)

| Characteristic | Symbol | Min | Typ | Max | Unit |
|--|-------------|-----|-----|-----|-----------------|
| OFF CHARACTERISTICS (Note 1) | | | | | |
| Collector–Emitter Clamping Voltage ($I_C = 7.0\text{ A}$) ($T_C = -40^\circ\text{C}$ to $+125^\circ\text{C}$) | V_{CLAMP} | 350 | – | 450 | Vdc |
| Collector–Emitter Cutoff Current ($V_{CE} = 200\text{ V}$, $I_B = 0$) | I_{CEO} | – | – | 100 | μAdc |
| Emitter–Base Leakage Current ($V_{EB} = 6.0\text{ Vdc}$, $I_C = 0$) | I_{EBO} | – | – | 50 | mAdc |

ON CHARACTERISTICS (Note 1)

| | | | | | |
|---|---------------|-------------|-------------|---------------------------------|-----|
| Base–Emitter Saturation Voltage ($I_C = 8.0\text{ Adc}$, $I_B = 100\text{ mAdc}$) ($I_C = 10\text{ Adc}$, $I_B = 0.25\text{ Adc}$) | $V_{BE(sat)}$ | – – | – – | 2.2 2.5 | Vdc |
| Collector–Emitter Saturation Voltage ($I_C = 7.0\text{ Adc}$, $I_B = 70\text{ mAdc}$) ($I_C = 8.0\text{ Adc}$, $I_B = 0.1\text{ Adc}$) ($I_C = 10\text{ Adc}$, $I_B = 0.25\text{ Adc}$) | $V_{CE(sat)}$ | – – – | – – – | 1.6 1.8 1.8 2.1 1.7 | Vdc |
| Base–Emitter On Voltage ($I_C = 5.0\text{ Adc}$, $V_{CE} = 2.0\text{ Vdc}$) ($I_C = 8.0\text{ Adc}$, $V_{CE} = 2.0\text{ Vdc}$) | $V_{BE(on)}$ | 1.1 1.3 | – – | 2.1 2.3 | Vdc |
| Diode Forward Voltage Drop ($I_F = 10\text{ Adc}$) | V_F | – | – | 2.5 | Vdc |
| DC Current Gain ($I_C = 6.5\text{ Adc}$, $V_{CE} = 1.5\text{ Vdc}$) ($I_C = 5.0\text{ Adc}$, $V_{CE} = 4.6\text{ Vdc}$) | h_{FE} | 150 500 | – – | – 3400 | – |

DYNAMIC CHARACTERISTICS

| | | | | | |
|--|----------|---|---|-----|-----|
| Current Gain Bandwidth ($I_C = 0.2\text{ Adc}$, $V_{CE} = 10\text{ Vdc}$, $f = 1.0\text{ MHz}$) | f_T | – | – | 2.0 | MHz |
| Output Capacitance ($V_{CB} = 10\text{ Vdc}$, $I_E = 0$, $f = 1.0\text{ MHz}$) | C_{ob} | – | – | 200 | pF |
| Input Capacitance ($V_{EB} = 6.0\text{ V}$) | C_{ib} | – | – | 550 | pF |

CLAMPING ENERGY (See Notes)

| | | | | | |
|--|-------------|-----|---|---|----|
| Repetitive Non–Destructive Energy Dissipated at turn–off: ($I_C = 7.0\text{ A}$, $L = 8.0\text{ mH}$, $R_{BE} = 100\ \Omega$) (see Figures 2 and 4) | W_{CLAMP} | 200 | – | – | mJ |
|--|-------------|-----|---|---|----|

SWITCHING CHARACTERISTICS: Inductive Load ($L = 10\text{ mH}$)

| | | | | | | |
|-----------------|--|----------|---|-----|----|---------------|
| Fall Time | ($I_C = 6.5\text{ A}$, $I_{B1} = 45\text{ mA}$, $V_{BE(off)} = 0$, $R_{BE(off)} = 0$, $V_{CC} = 14\text{ V}$, $V_Z = 300\text{ V}$) | t_{fi} | – | 625 | – | ns |
| Storage Time | | t_{si} | – | 10 | 30 | μs |
| Cross–over Time | | t_c | – | 1.7 | – | μs |

1. Pulse Test: Pulse Width $\leq 300\ \mu\text{s}$, Duty Cycle = 2.0%.

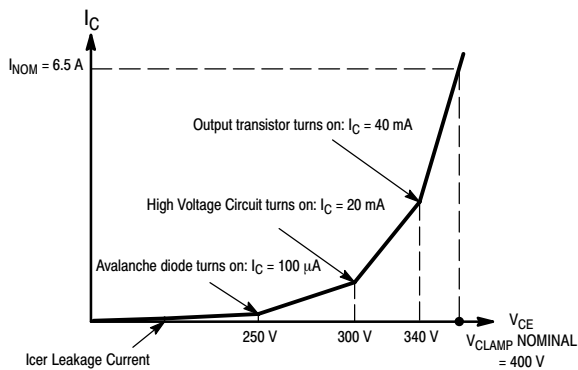

Figure 1. $I_C = f(V_{CE})$ Curve Shape

By design, the BU323Z has a built-in avalanche diode and a special high voltage driving circuit. During an auto-protect cycle, the transistor is turned on again as soon as a voltage, determined by the zener threshold and the network, is reached. This prevents the transistor from going into a Reverse Bias Operating limit condition. Therefore, the device will have an extended safe operating area and will always appear to be in “FBSOA.” Because of the built-in zener and associated network, the $I_C = f(V_{CE})$ curve exhibits an unfamiliar shape compared to standard products as shown in Figure 1.

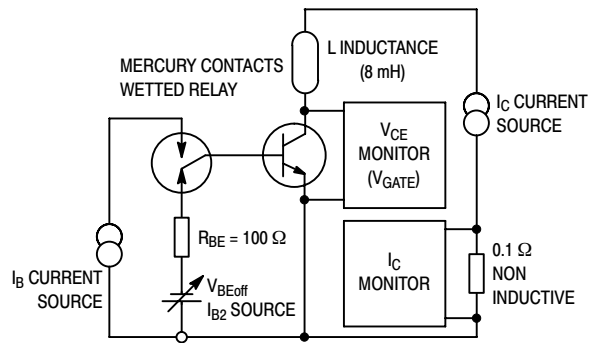

Figure 2. Basic Energy Test Circuit

The bias parameters, V_{CLAMP} , I_{B1} , $V_{BE(off)}$, I_{B2} , I_C , and the inductance, are applied according to the Device Under Test (DUT) specifications. V_{CE} and I_C are monitored by the test system while making sure the load line remains within the limits as described in Figure 4.

Note: All BU323Z ignition devices are 100% energy tested, per the test circuit and criteria described in Figures 2 and 4, to the minimum guaranteed repetitive energy, as specified in the device parameter section. The device can sustain this energy on a repetitive basis without degrading any of the specified electrical characteristics of the devices. The units under test are kept functional during the complete test sequence for the test conditions described:

$I_{C(peak)} = 7.0 \text{ A}$, $I_{CH} = 5.0 \text{ A}$, $I_{CL} = 100 \text{ mA}$, $I_B = 100 \text{ mA}$, $R_{BE} = 100 \text{ } \Omega$, $V_{gate} = 280 \text{ V}$, $L = 8.0 \text{ mH}$

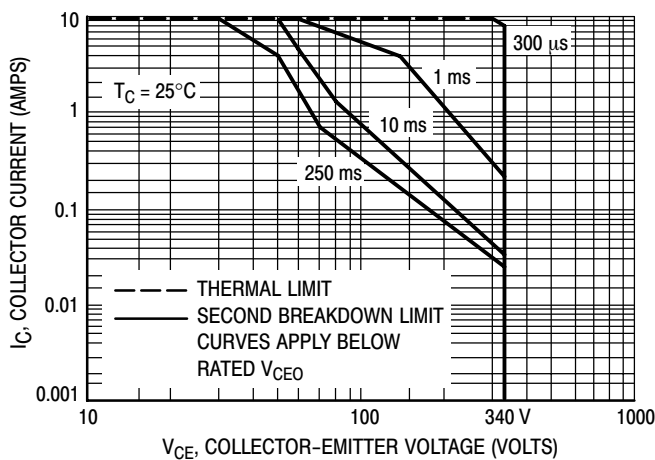
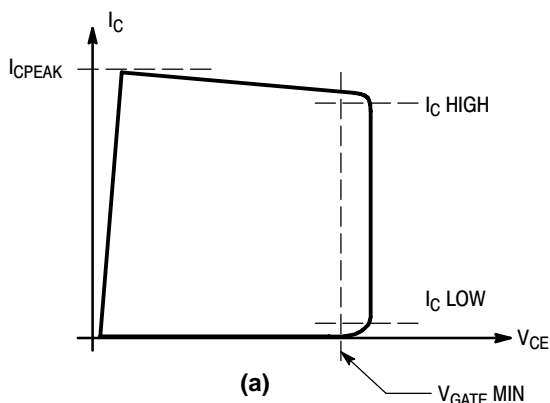
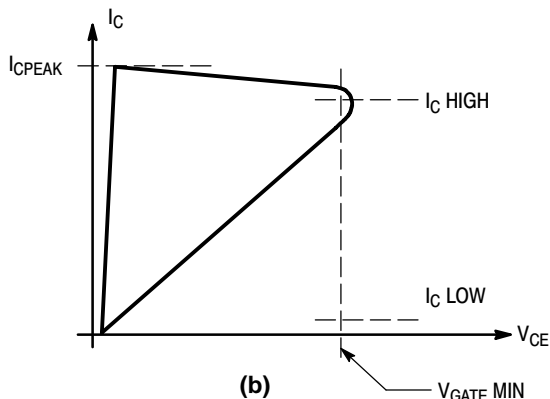

Figure 3. Forward Bias Safe Operating Area



The shaded area represents the amount of energy the device can sustain, under given DC biases ($I_C/I_B/V_{BE(off)}/R_{BE}$), without an external clamp; see the test schematic diagram, Figure 2.

The transistor **PASSES** the Energy test if, for the inductive load and $I_{CPEAK}/I_B/V_{BE(off)}$ biases, the V_{CE} remains outside the shaded area and greater than the V_{GATE} minimum limit, Figure 4a.



The transistor **FAILS** if the V_{CE} is less than the V_{GATE} (minimum limit) at any point along the V_{CE}/I_C curve as shown on Figures 4b, and 4c. This assures that hot spots and uncontrolled avalanche are not being generated in the die, and the transistor is not damaged, thus enabling the sustained energy level required.

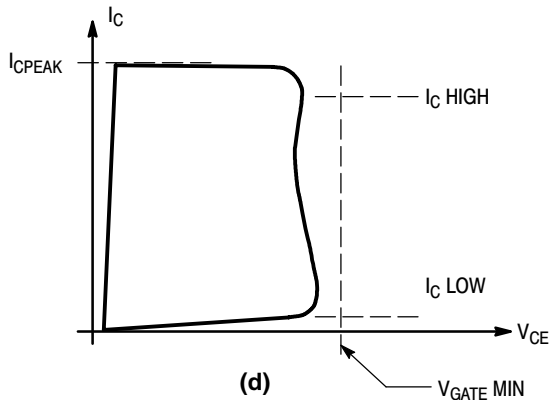
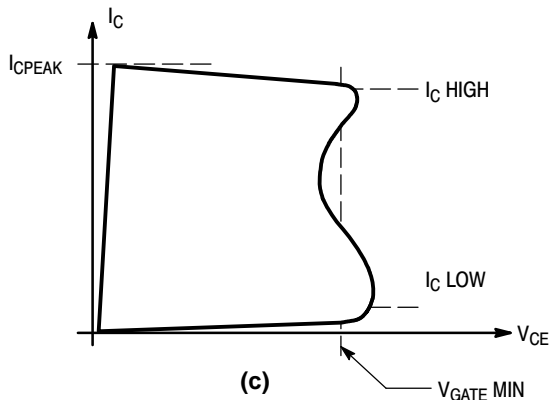

The transistor **FAILS** if its Collector/Emitter breakdown voltage is less than the V_{GATE} value, Figure 4d.

Figure 4. Energy Test Criteria for BU323Z

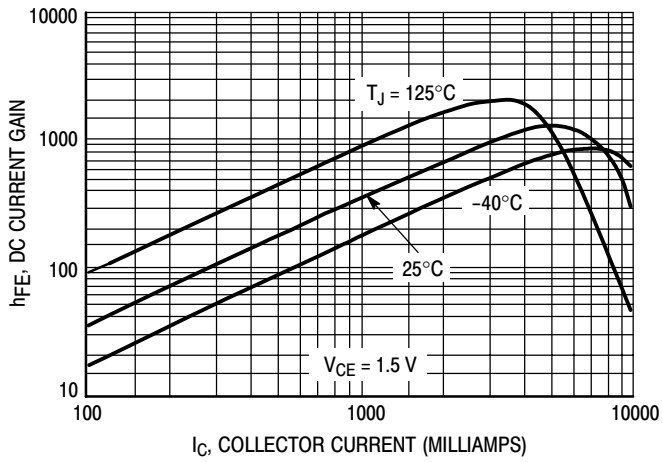

Figure 5. DC Current Gain

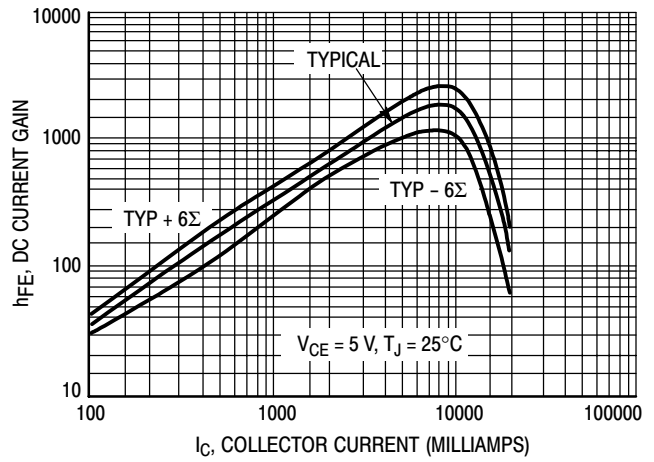

Figure 6. DC Current Gain

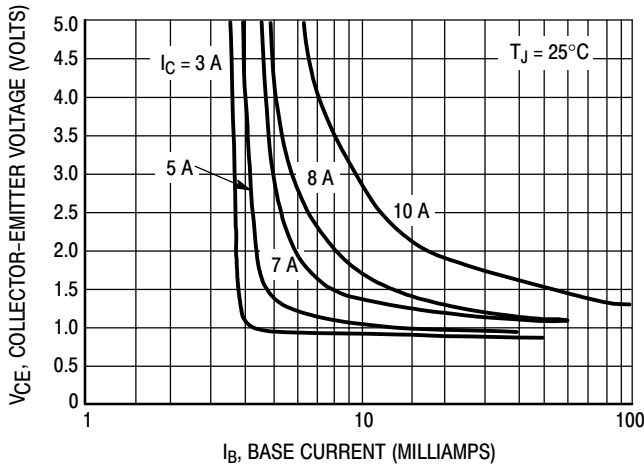

Figure 7. Collector Saturation Region

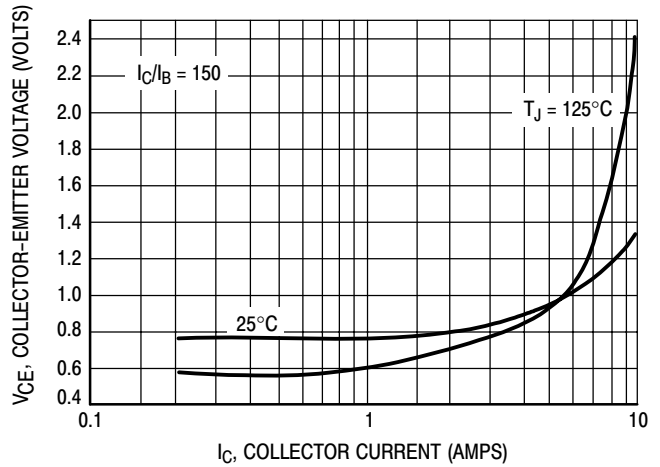

Figure 8. Collector-Emmitter Saturation Voltage

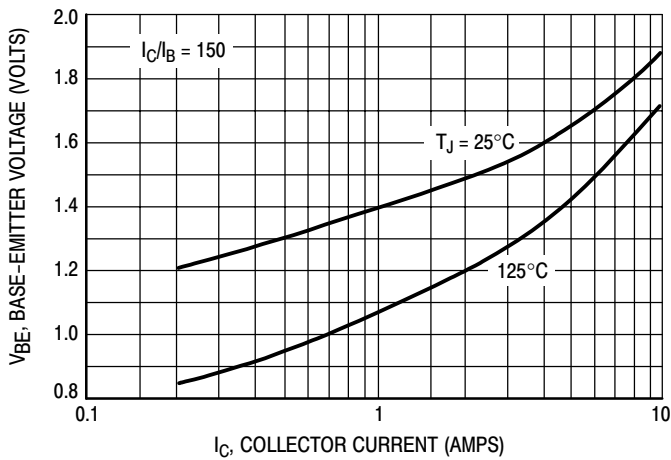

Figure 9. Base-Emmitter Saturation Voltage

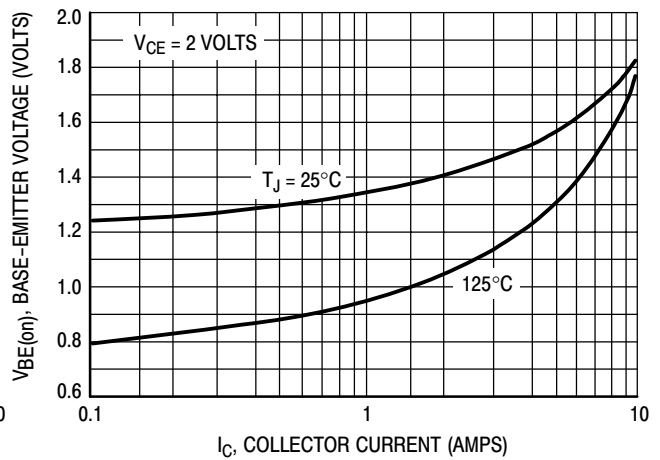

Figure 10. Base-Emmitter "ON" Voltages

BUB323Z

ORDERING INFORMATION

| Device | Package | Shipping† |
|------------|---------------------------------|-------------------------|
| BUB323Z | D ² PAK | 50 Units / Rail |
| BUB323ZG | D ² PAK (Pb-Free) | 50 Units / Rail |
| BUB323ZT4 | D ² PAK | 800 Units / Tape & Reel |
| BUB323ZT4G | D ² PAK (Pb-Free) | 800 Units / Tape & Reel |

†For information on tape and reel specifications, including part orientation and tape sizes, please refer to our Tape and Reel Packaging Specifications Brochure, BRD8011/D.

BUB323Z

PACKAGE DIMENSIONS

D²PAK
CASE 418B-04
ISSUE J

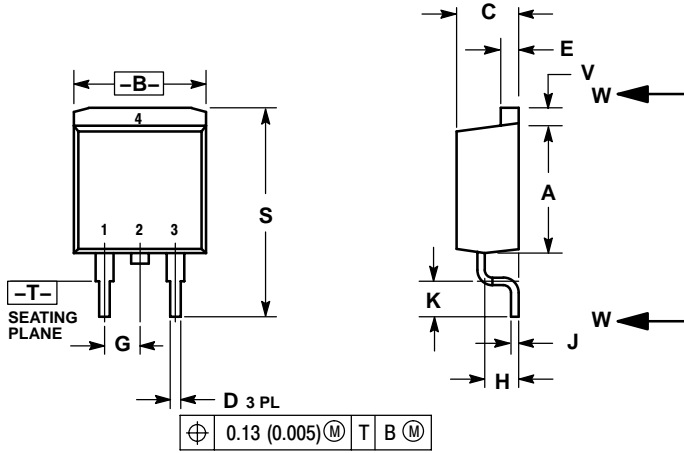

- NOTES:
1. DIMENSIONING AND TOLERANCING PER ANSI Y14.5M, 1982.
 2. CONTROLLING DIMENSION: INCH.
 3. 418B-01 THRU 418B-03 OBSOLETE, NEW STANDARD 418B-04.

| DIM | INCHES | | MILLIMETERS | |
|-----|-----------|-------|-------------|-------|
| | MIN | MAX | MIN | MAX |
| A | 0.340 | 0.380 | 8.64 | 9.65 |
| B | 0.380 | 0.405 | 9.65 | 10.29 |
| C | 0.160 | 0.190 | 4.06 | 4.83 |
| D | 0.020 | 0.035 | 0.51 | 0.89 |
| E | 0.045 | 0.055 | 1.14 | 1.40 |
| F | 0.310 | 0.350 | 7.87 | 8.89 |
| G | 0.100 BSC | | 2.54 BSC | |
| H | 0.080 | 0.110 | 2.03 | 2.79 |
| J | 0.018 | 0.025 | 0.46 | 0.64 |
| K | 0.090 | 0.110 | 2.29 | 2.79 |
| L | 0.052 | 0.072 | 1.32 | 1.83 |
| M | 0.280 | 0.320 | 7.11 | 8.13 |
| N | 0.197 REF | | 5.00 REF | |
| P | 0.079 REF | | 2.00 REF | |
| R | 0.039 REF | | 0.99 REF | |
| S | 0.575 | 0.625 | 14.60 | 15.88 |
| V | 0.045 | 0.055 | 1.14 | 1.40 |

STYLE 1:

- PIN 1. BASE
- COLLECTOR
- EMITTER
- COLLECTOR

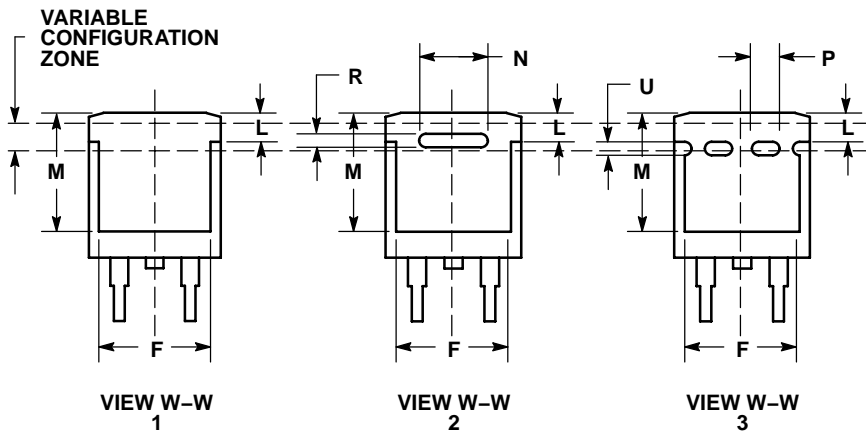

SOLDERING FOOTPRINT*

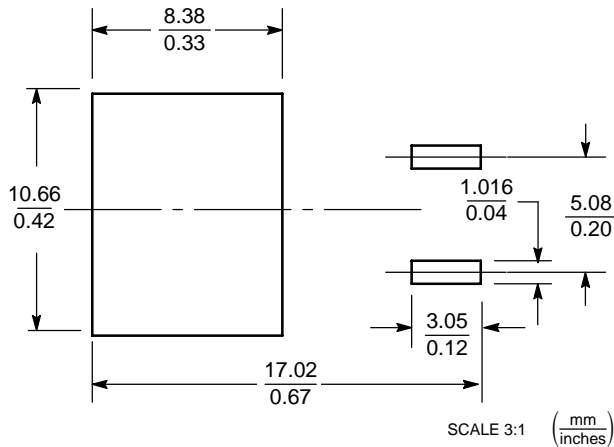

*For additional information on our Pb-Free strategy and soldering details, please download the ON Semiconductor Soldering and Mounting Techniques Reference Manual, SOLDERRM/D.

BUB323Z

ON Semiconductor and **ON** are registered trademarks of Semiconductor Components Industries, LLC (SCILLC). SCILLC reserves the right to make changes without further notice to any products herein. SCILLC makes no warranty, representation or guarantee regarding the suitability of its products for any particular purpose, nor does SCILLC assume any liability arising out of the application or use of any product or circuit, and specifically disclaims any and all liability, including without limitation special, consequential or incidental damages. "Typical" parameters which may be provided in SCILLC data sheets and/or specifications can and do vary in different applications and actual performance may vary over time. All operating parameters, including "Typicals" must be validated for each customer application by customer's technical experts. SCILLC does not convey any license under its patent rights nor the rights of others. SCILLC products are not designed, intended, or authorized for use as components in systems intended for surgical implant into the body, or other applications intended to support or sustain life, or for any other application in which the failure of the SCILLC product could create a situation where personal injury or death may occur. Should Buyer purchase or use SCILLC products for any such unintended or unauthorized application, Buyer shall indemnify and hold SCILLC and its officers, employees, subsidiaries, affiliates, and distributors harmless against all claims, costs, damages, and expenses, and reasonable attorney fees arising out of, directly or indirectly, any claim of personal injury or death associated with such unintended or unauthorized use, even if such claim alleges that SCILLC was negligent regarding the design or manufacture of the part. SCILLC is an Equal Opportunity/Affirmative Action Employer. This literature is subject to all applicable copyright laws and is not for resale in any manner.

PUBLICATION ORDERING INFORMATION

LITERATURE FULFILLMENT:

Literature Distribution Center for ON Semiconductor
P.O. Box 61312, Phoenix, Arizona 85082-1312 USA
Phone: 480-829-7710 or 800-344-3860 Toll Free USA/Canada
Fax: 480-829-7709 or 800-344-3867 Toll Free USA/Canada
Email: orderlit@onsemi.com

N. American Technical Support: 800-282-9855 Toll Free
USA/Canada

Japan: ON Semiconductor, Japan Customer Focus Center
2-9-1 Kamimeguro, Meguro-ku, Tokyo, Japan 153-0051
Phone: 81-3-5773-3850

ON Semiconductor Website: <http://onsemi.com>

Order Literature: <http://www.onsemi.com/litorder>

For additional information, please contact your
local Sales Representative.

BUB323Z/D