

ESCO23M-15 (5A)

(600V,1500V / 5A)

LOW LOSS SUPER HIGH SPEED RECTIFIER

Features

- Insulated package by fully molding
- Low VF
- Super high speed switching
- High reliability by planer design

Applications

- High speed power switching

Maximum ratings and characteristics

- Absolute maximum ratings

Outline drawings, mm

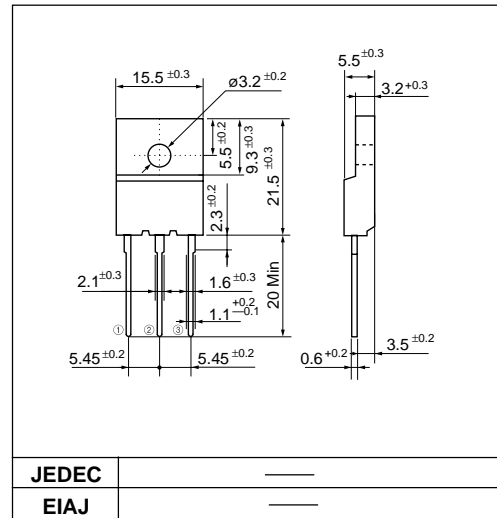

Connection diagram

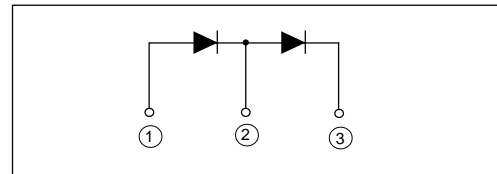

Item	Symbol	Conditions	Rating		Unit
			① to ②	② to ③	
Repetitive peak reverse voltage	V_{RRM}		600	1500	V
Repetitive peak surge reverse voltage	V_{RSM}		600	1500	V
Isolating voltage	V_{iso}	Terminals to Case, AC. 1min.	1500		V
Average output current	I_o	$T_c=100^{\circ}C$	5		A
Surge current	I_{FSM}	Sine wave 10ms	50	80	A
Operating junction temperature	T_j		-40 to +150		$^{\circ}C$
Storage temperature	T_{stg}		-40 to +150		$^{\circ}C$

- Electrical characteristics ($T_a=25^{\circ}C$ Unless otherwise specified)

Item	Symbol	Conditions	Max.		Unit
			① to ②	② to ③	
Forward voltage drop	V_{FM}	$I_{FM}=4A$	3.0	1.8	V
Reverse current	I_{RRM}	$V_R=V_{RRM}$	500	50	μA
Reverse recovery time	t_{rr}	$I_F=0.1A, I_R=0.1A$	0.15	0.6	μs
Thermal resistance	$R_{th(j-c)}$	Junction to case	2.5		$^{\circ}C/W$

Characteristics

(1)-(2) Forward Characteristic (typ.)

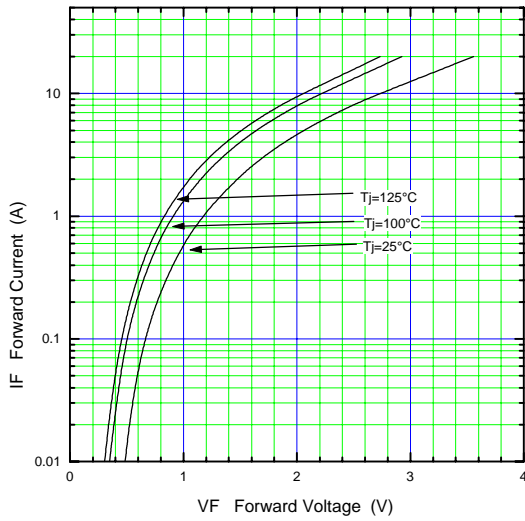

(2)-(3) Forward Characteristic (typ.)

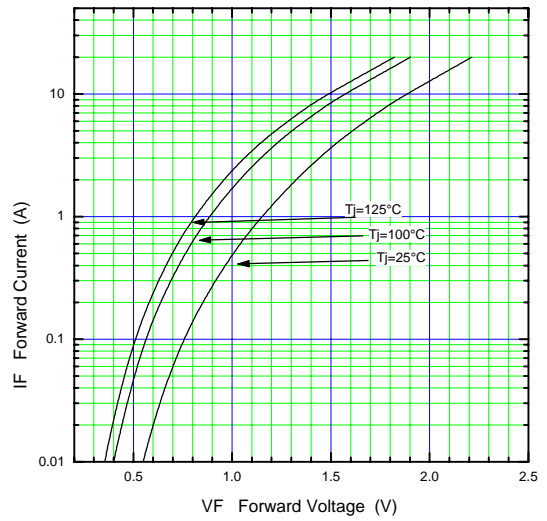

(1)-(2) Reverse Characteristic (typ.)

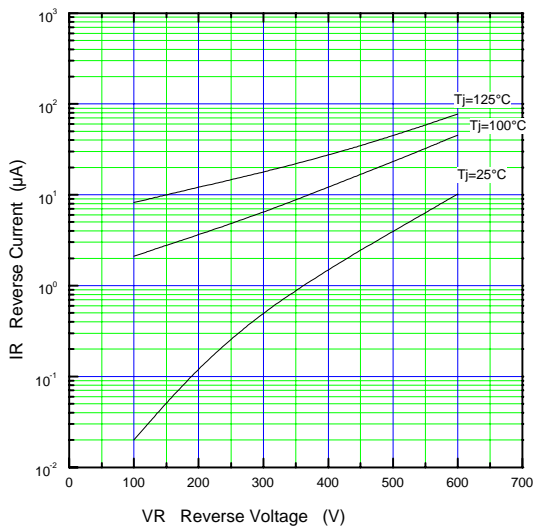

(2)-(3) Reverse Characteristic (typ.)

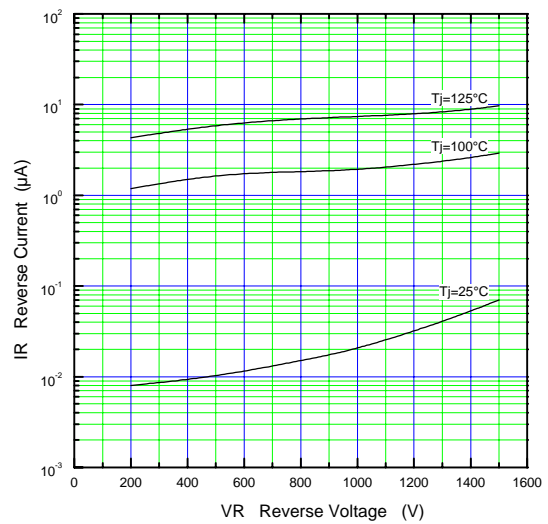

(1)-(2) Junction Capacitance Characteristic (typ.)

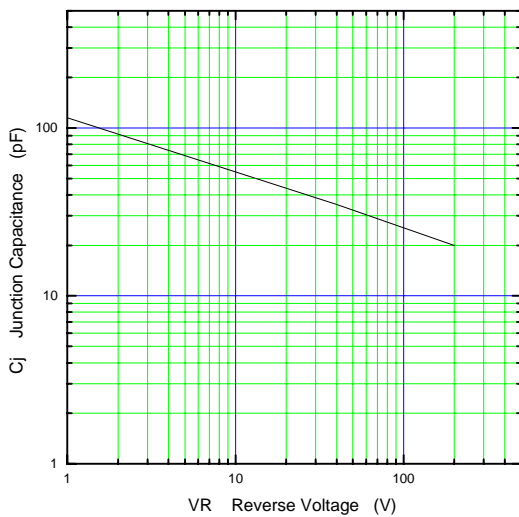

(2)-(3) Junction Capacitance Characteristic (typ.)

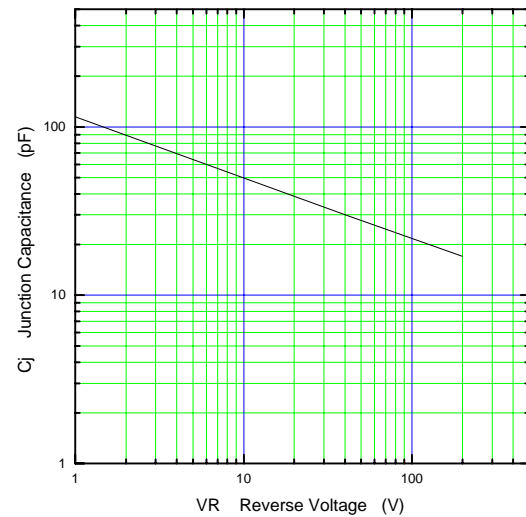

(1)-(2) Surge Capability

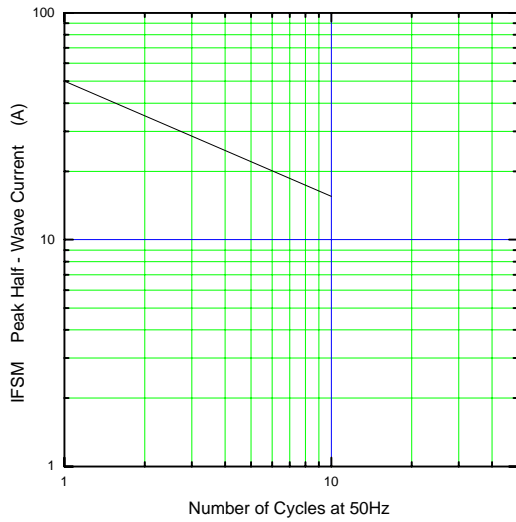

(2)-(3) Surge Capability

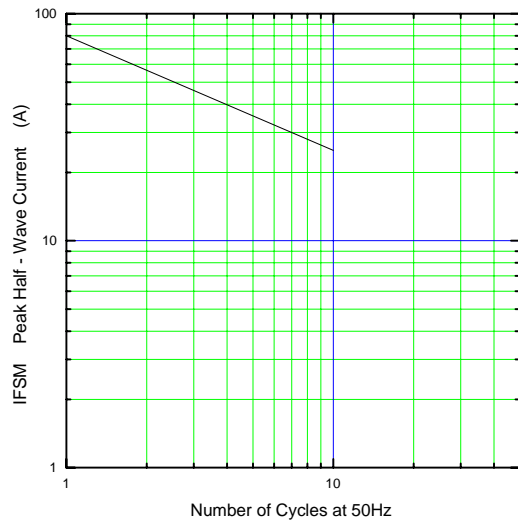

Current Derating (Io-Tc)

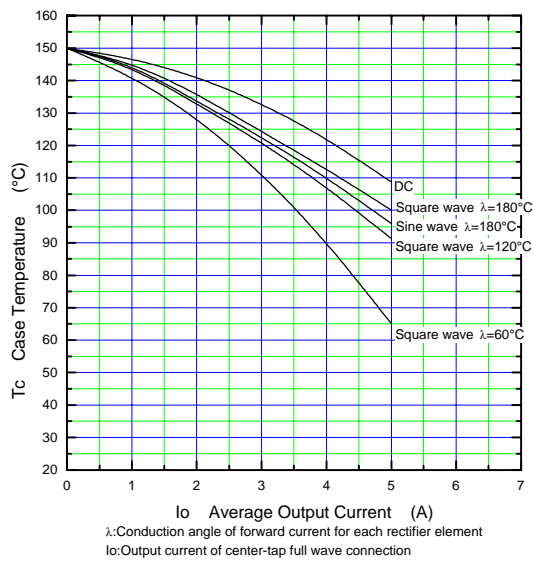

Transient Thermal Impedance

