

POWER RELAY

2 POLE 5A/TV-3 RATED COMPACT TYPE

FTR-F4 Series

RoHS compliant

■ FEATURES

- Small high density type relay 288mm² save 24% compared to VB
- UL/CSA TV-3 rating
- Insulation distance: minimum 6 mm between coil and contacts (IEC65)
Dielectric strength: 4 KVAV
Surge strength: 10 KV
- Card separation system for high noise resistance between coil and contacts
- UL 94V-0 flamability materials, UL Class B (130°C)
- Safety standards
UL, CSA, VDE, SEMKO pending
- RoHS compliant since date code: 0437L2
Please see page 5 for more information



■ APPLICATIONS

- CRT monitor EMI protection
- Audio system speaker protection

■ ORDERING INFORMATION

[Example] $\frac{\text{FTR-F4}}{\text{(a)}} \quad \frac{\text{A}}{\text{(b)}} \quad \frac{\text{K}}{\text{(c)}} \quad \frac{\text{012}}{\text{(d)}} \quad \frac{\text{T}}{\text{(e)}} \quad \frac{\text{-**}}{\text{(f)}}$

(a)	Series Name	FTR-F4 : FTR-F4 Series
(b)	Contact Arrangement	A : 2 form A (DPST)
(c)	Coil Type	K : Standard type (530 mW)
(d)	Nominal Voltage	005 : 5 VDC, 006 : 6VDC, 009 : 9VDC 012 : 12VDC, 024 : 24VDC, 048 : 48VDC
(e)	TV-Rating	T : TV-3
(f)	Custom Designation	Special number for customized products

Ordering Code: FTR-F4AK012T Actual Marking: F4AK012T

FTR-F4 SERIES

■ SAFETY STANDARD AND FILE NUMBERS

UL508

C22.2 No. 1, No. 14

Please note that UL/CSA ratings may differ from the standard ratings. Please request when the approval markings are required on the cover and/or relay recognized by SEV is required.

Nominal Voltage	Contact Rating
5 to 48 VDC	TV-3, 120 VAC 1/6 HP 125 VAC 1/4HP 277 VAC 5A 30VDC/ 277 VAC res. Pilot duty D300

■ SPECIFICATIONS

Item		FTR-F4	
Contact	Arrangement	2 form A (DPST)	
	Material	Silver alloy	
	Style	Single	
	Resistance (initial)	Maximum 100 mΩ (at 1 A 6 VDC)	
	Rating (resistive)	5A 277 VAC 30 VDC	
	Maximum Carrying Current	5 A	
	Maximum Switching Power	1,250VA / 150 W	
	Maximum Switching Voltage	400 VAC / 300 VDC	
	Maximum Switching Current	5 A	
	Minimum Switching Load*1	5 VDC, 100mA	
	Maximum Inrush Current	120 VAC, 51A (TV-3)	
	Coil	Nominal Power(at 20°C)	0.53 W
Operate Power (at 20°C)		0.3 W	
Operating Temperature		-40°C to +70°C (no frost)	
Time Value	Operate (at nominal voltage)	Maximum 15 ms (not including bounce)	
	Release (at nominal voltage)	Maximum 5 ms (not including bounce)	
Insulation	Resistance (at 500 VDC)	Minimum 1,000 MΩ	
	Dielectric Strength	between open contacts	1,000 VAC 1 minute
		between adjacent contacts	3,000VAC 1 minute
		between coil and contacts	4,000 VAC 1 minute
Surge Strength	10,000 V (at 1.2 × 50 μs)(between coil and contacts)		
Life	Mechanical	2 × 10 ⁶ operations minimum	
	Electrical	Contact rating	1 × 10 ⁵ operations minimum
		Lamp load	2.5 × 10 ⁴ operations minimum
Vibration	Misoperation	10 to 55 Hz (double amplitude of 1.5 mm)	
	Endurance	10 to 55 Hz (double amplitude of 1.5 mm)	
Shock	Misoperation	200 m/s ² (11 ±1 ms)	
	Endurance	1,000 m/s ² (6 ±1 ms)	
Weight		Approximately 12 g	

*1 Minimum switching loads mentioned above are reference values. Please perform the confirmation test with the actual load before production since reference values may vary according to switching frequencies, environmental conditions and expected reliability levels.

FTR-F4 SERIES

COIL DATA CHART

Standard type

MODEL	Nominal voltage	Coil resistance ($\pm 10\%$)	Operate voltage	Release voltage	Nominal power
FTR-F4AK005T	5 VDC	47 Ω	3.75 VDC	0.25 VDC	530 mW
FTR-F4AK006T	6 VDC	68 Ω	4.5 VDC	0.3 VDC	530 mW
FTR-F4AK009T	9 VDC	155 Ω	6.75 VDC	0.45 VDC	530 mW
FTR-F4AK012T	12 VDC	270 Ω	9.0 VDC	0.6 VDC	530 mW
FTR-F4AK024T	24 VDC	1,100 Ω	18.0 VDC	1.2 VDC	530 mW
FTR-F4AK048T	48 VDC	4,400 Ω	36.0 VDC	2.4 VDC	530 mW

Note: All values in the table are measured at 20°C.

CHARACTERISTIC DATA

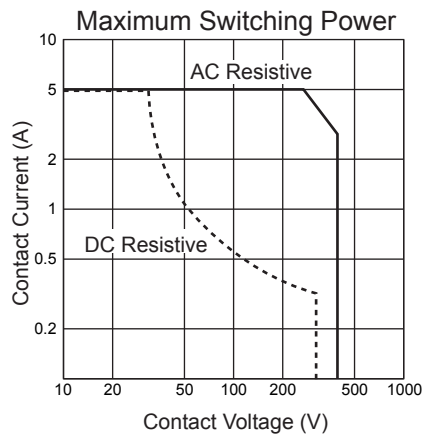
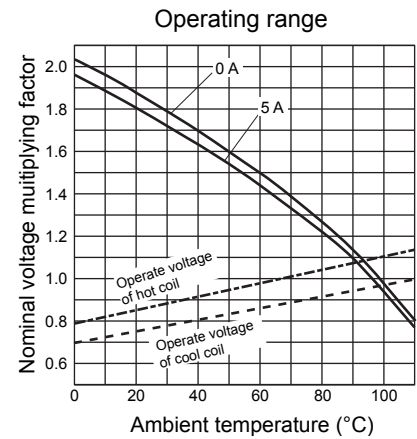
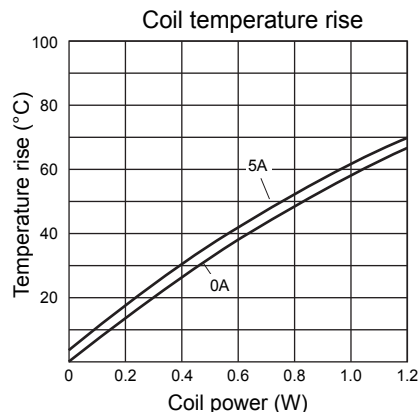
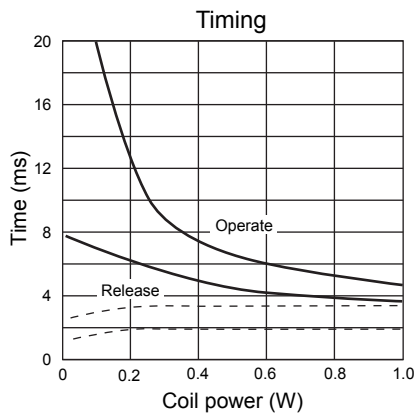

FTR-F4 SERIES

REFERENCE DATA

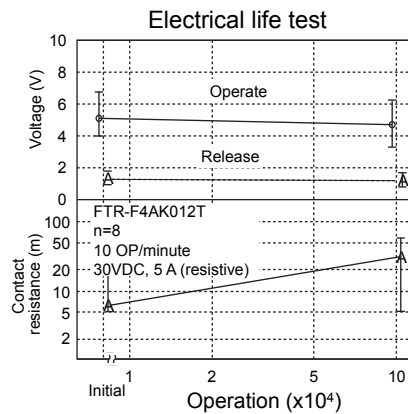
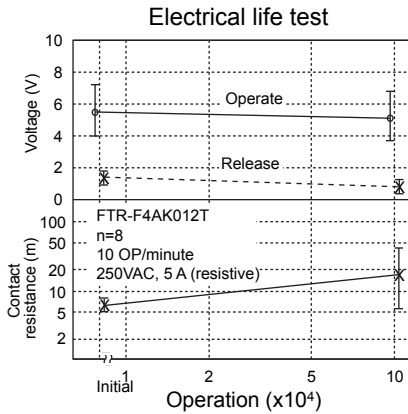
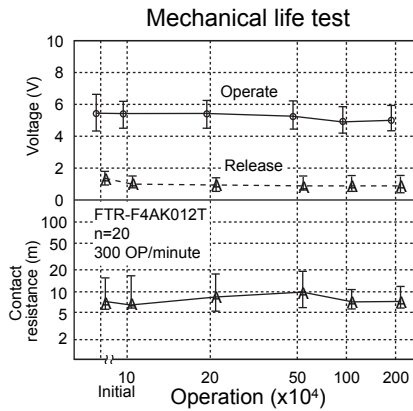
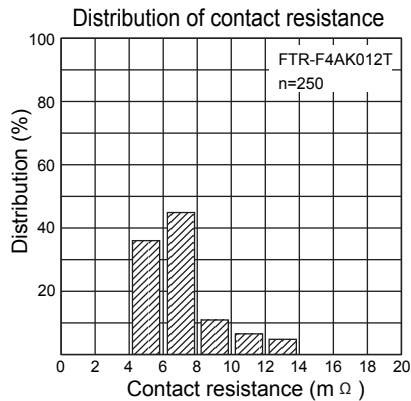
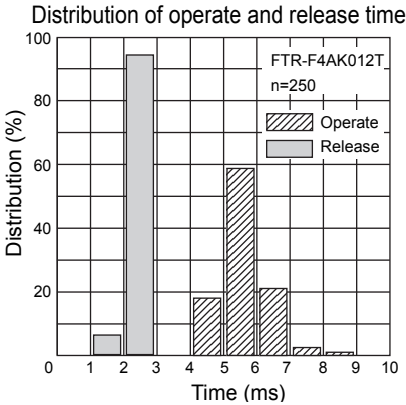
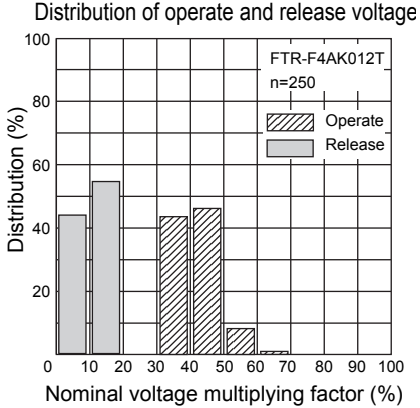

DIMENSIONS

Dimensions

FTR-F4 type

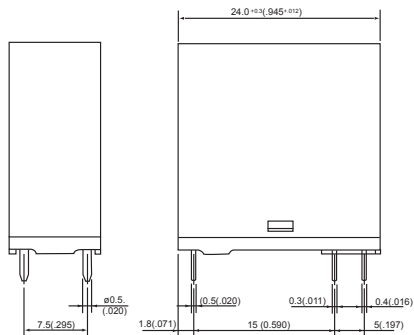

Schematics (BOTTOM VIEW)

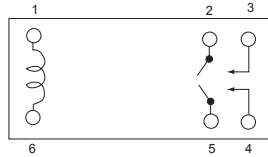

PC board mounting hole layout (BOTTOM VIEW)

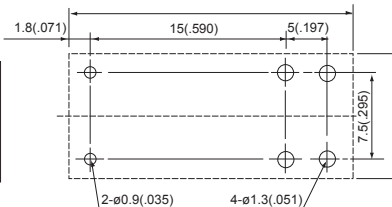

Unit: mm

RoHS Compliance and Lead Free Relay Information

1. General Information

- Relays produced after the specific date code that is indicated on each data sheet are lead-free now. Most of our signal and power relays are lead-free. Please refer to Lead-Free Status Info. (<http://www.fujitsu.com/us/downloads/MICRO/fcai/relays/lead-free-letter.pdf>)
- Lead free solder paste currently used in relays is Sn-3.0Ag-0.5Cu.
- All signal and most power relays also comply with RoHS. Please refer to individual data sheets. Relays that are RoHS compliant do not contain the 5 hazardous materials that are restricted by RoHS directive (lead, mercury, chromium IV, PBB, PBDE).
- It has been verified that using lead-free relays in leaded assembly process will not cause any problems (compatible).
- "LF" is marked on each outer and inner carton. (No marking on individual relays).
- To avoid leaded relays (for lead-free sample, etc.) please consult with area sales office.
- We will ship leaded relays as long as the leaded relay inventory exists.

Note: Cadmium was exempted from RoHS on October 21, 2005. (Amendment to Directive 2002/95/EC)

2. Recommended Lead Free Solder Profile

- Recommended solder paste Sn-3.0Ag-0.5Cu.

Reflow Solder condition

Flow Solder condition:

Pre-heating: maximum 120°C
Soldering: dip within 5 sec. at
260°C solder bath

Solder by Soldering Iron:

Soldering Iron
Temperature: maximum 360°C
Duration: maximum 3 sec.

We highly recommend that you confirm your actual solder conditions

3. Moisture Sensitivity

- Moisture Sensitivity Level standard is not applicable to electromechanical relays.

4. Tin Whisker

- Dipped SnAgCu solder is known as low risk tin whisker. No considerable length whisker was found by our in house test.

Fujitsu Components International Headquarter Offices

Japan

Fujitsu Component Limited
Gotanda-Chuo Building
3-5, Higashigotanda 2-chome, Shinagawa-ku
Tokyo 141, Japan
Tel: (81-3) 5449-7010
Fax: (81-3) 5449-2626
Email: promothq@ft.ed.fujitsu.com
Web: www.fcl.fujitsu.com

North and South America

Fujitsu Components America, Inc.
250 E. Caribbean Drive
Sunnyvale, CA 94089 U.S.A.
Tel: (1-408) 745-4900
Fax: (1-408) 745-4970
Email: marcom@fcai.fujitsu.com
Web: <http://www.fujitsu.com/us/services/edevices/components/>

Europe

Fujitsu Components Europe B.V.
Diamantlaan 25
2132 WV Hoofddorp
Netherlands
Tel: (31-23) 5560910
Fax: (31-23) 5560950
Email: info@fceu.fujitsu.com
Web: <http://www.fujitsu.com/emea/services/components/>

Asia Pacific

Fujitsu Components Asia Ltd.
102E Pasir Panjang Road
#04-01 Citilink Warehouse Complex
Singapore 118529
Tel: (65) 6375-8560
Fax: (65) 6273-3021
Email: fcal@fcal.fujitsu.com
Web: <http://www.fujitsu.com/sg/services/micro/components/>

©2005 Fujitsu Components America, Inc. All rights reserved. All trademarks or registered trademarks are the property of their respective owners.

Fujitsu Components America does not warrant that the content of datasheet is error free. In a continuing effort to improve our products Fujitsu Components America, Inc. reserves the right to change specifications/datasheets without prior notice. Rev. 11/18/2005.