

KA5Q0565RT

Fairchild Power Switch(FPS)

Features

- Quasi Resonant Converter Controller
- Internal Burst Mode Controller for Stand-by Mode
- Pulse by Pulse Current Limiting
- Over Current Latch Protection
- Over Voltage Protection (Vcc: Min. 27V)
- Internal Thermal Shutdown Function
- Under Voltage Lockout
- Internal High Voltage Sense FET
- Auto-Restart Mode

Description

The Fairchild Power Switch(FPS) product family is specially designed for an off-line SMPS with minimal external components. The Fairchild Power Switch(FPS) consists of a high voltage power SenseFET and a current mode PWM IC. The integrated PWM controller includes the fixed oscillator, the under voltage lock out, the leading edge blanking, the optimized gate turn-on/turn-off driver, the thermal shut down protection, the over voltage protection, and the temperature compensated precision current sources for loop compensation and fault protection circuitry. Compared to a discrete MOSFET and a controller or a RCC switching converter solutions, a Fairchild Power Switch(FPS) can reduce the total number of components, design size, and weight, so it will improve efficiency, productivity, and system reliability. It has a basic platform well suited for cost-effective design in a quasi-resonant converter as a C-TV power supply.



Internal Block Diagram

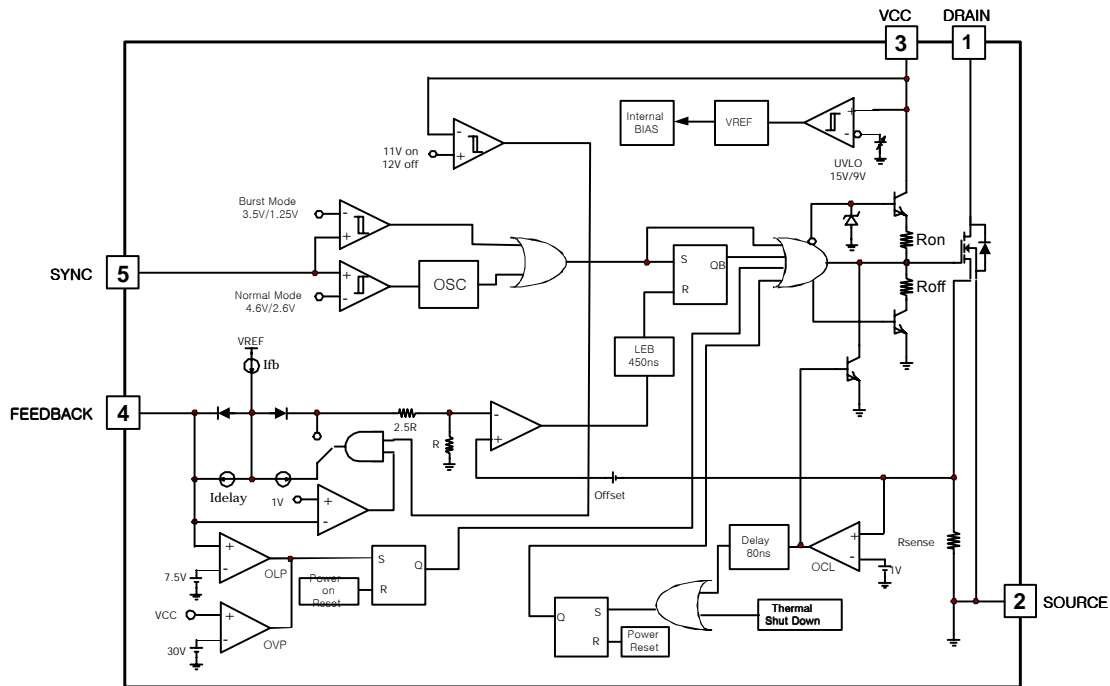

Absolute Maximum Ratings

(Ta=25°C, unless otherwise specified)

Parameter	Symbol	Value	Unit
Drain-Gate Voltage (RGS=1MΩ)	VDGR	650	V
Gate-Source (GND) Voltage	VGS	±30	V
Drain Current Pulsed ⁽²⁾	IDM	20	ADC
Single Pulsed Avalanche Current ⁽³⁾ (Energy ⁽²⁾)	IAS(EAS)	13(400)	A(mJ)
Continuous Drain Current (Tc = 25°C)	ID	5.0	ADC
Continuous Drain Current (TC=100°C)	ID	3.5	ADC
Supply Voltage	VCC	30	V
Input Voltage Range	VFB	-0.3 to Vcc	V
Total Power Dissipation	PD	38	W
	Derating	0.3	W/°C
Operating Junction Temperature	TJ	+160	°C
Operating Ambient Temperature	TA	-25 to +85	°C
Storage Temperature Range	TSTG	-55 to +150	°C
Thermal Resistance	Rthjc	3.29	°C/W

Notes:

1. Tj = 25°C to 150°C
2. Repetitive rating: Pulse width limited by maximum junction temperature
3. L = 30mH, VDD = 50V, RG = 25Ω, starting Tj = 25°C
4. L = 13uH, starting Tj = 25°C

Electrical Characteristics (SFET Part)

(Ta=25°C unless otherwise specified)

Parameter	Symbol	Condition	Min.	Typ.	Max.	Unit
Drain-Source Breakdown Voltage	BV _{DSS}	V _{GS} = 0V, I _D = 50μA	650	-	-	V
Zero Gate Voltage Drain Current	I _{DSS}	V _{DS} = Max, Rating, V _{GS} = 0V	-	-	200	μA
		V _{DS} = 0.8*Max., Rating V _{GS} = 0V, T _C = 85°C	-	-	300	μA
Static Drain-source on Resistance ^(Note)	R _{DS(ON)}	V _{GS} = 10V, I _D = 2.3A	-	1.8	2.2	Ω
Input Capacitance	C _{iss}	V _{GS} = 0V, V _{DS} = 25V, f = 1MHz	-	780	-	pF
Output Capacitance	C _{oss}		-	90	-	
Reverse Transfer Capacitance	C _{rss}		-	40	-	
Turn on Delay Time	t _{d(on)}	V _{DD} = 0.5BV _{DSS} , I _D = 7.0A (MOSFET switching time are essentially independent of operating temperature)	-	15	40	nS
Rise Time	t _r		-	45	100	
Turn Off Delay Time	t _{d(off)}		-	60	130	
Fall Time	t _f		-	40	90	
Total Gate Charge (Gate-Source+Gate-Drain)	Q _g	V _{GS} = 10V, I _D = 7.0A, V _{DS} = 0.5B V _{DSS} (MOSFET Switching time are Essentially independent of operating temperature)	-	43	55	nC
Gate-Source Charge	Q _{gs}		-	4.0	-	
Gate-Drain (Miller) Charge	Q _{gd}		-	7.3	-	

Note:

1. Pulse test : Pulse width ≤ 300μS, duty ≤ 2%

Electrical Characteristics (Continued)

(Ta=25°C unless otherwise specified)

Parameter	Symbol	Condition	Min.	Typ.	Max.	Unit
UVLO SECTION						
Start Threshold Voltage	VSTART	VFB = GND	14	15	16	V
Stop Threshold Voltage	VSTOP	VFB = GND	8	9	10	V
OSCILLATOR SECTION						
Initial Frequency	FOSC	-	18	20	22	kHz
Voltage Stability	FSTABLE	12V ≤ Vcc ≤ 23V	0	1	3	%
Temperature Stability (Note2)	ΔFOSC	-25°C ≤ Ta ≤ 85°C	0	±5	±10	%
Maximum Duty Cycle	DMAX	-	92	95	98	%
Minimum Duty Cycle	DMIN	-	-	-	0	%
FEEDBACK SECTION						
Feedback Source Current	IFB	VFB = GND	0.7	0.9	1.1	mA
Shutdown Feedback Voltage	VSD	Vfb ≥ 6.9V	6.9	7.5	8.1	V
Shutdown Delay Current	IDELAY	VFB = 5V	4	5	6	μA
PROTECTION SECTION						
Over Voltage Protection	VCCOVP	VCC ≥ 26V	27	30	33	V
Over Current Latch Voltage (Note2)	VOCL	-	0.9	1.0	1.1	V
Thermal Shutdown Temp.	TSD	-	140	160	-	°C
SYNC SECTION						
Normal Sync High Threshold Voltage	VNSH	VCC = 16V, Vfb = 5V	4.0	4.6	5.2	V
Normal Sync Low Threshold Voltage	VNSL	VCC = 16V, Vfb = 5V	2.3	2.6	2.9	V
Burst Sync High Threshold Voltage	VBSH	VCC = 10.5V, Vfb = 0V	3.2	3.6	4.0	V
Burst Sync Low Threshold Voltage	VBSL	VCC = 10.5V, Vfb = 0V	1.1	1.3	1.5	V

Note:

1. These parameters is the current flowing in the Control IC.
2. These parameters, although guaranteed, are tested in EDS(wafer test) process.
3. These parameters indicate Inductor Current.

Electrical Characteristics (Continued)

(Ta=25°C unless otherwise specified)

Parameter	Symbol	Condition	Min.	Typ.	Max.	Unit
BURST MODE SECTION						
Burst Mode Low Threshold Voltage	VBURL	Vfb = 0V	10.4	11.0	11.6	V
Burst Mode High Threshold Voltage	VBURH	Vfb = 0V	11.4	12.0	12.6	V
Burst Mode Enable Feedback Voltage	VBEN	Vcc = 10.5V	0.7	1.0	1.3	V
Burst Mode Peak Current Limit	IBU_PK	Vcc = 10.5V	0.65	0.85	1.1	A
CURRENT LIMIT(SELF-PROTECTION)SECTION						
Peak Current Limit(Note3)	IPK	-	3.08	3.5	3.92	A
TOTAL DEVICE SECTION						
Start Up Current	I _{START}	Vfb = GND, V _{CC} = 14V	-	0.1	0.2	mA
Operating Supply Current (Note1)	I _{OP}	Vfb = GND, V _{CC} = 16V	-	10	18	mA
	I _{OP(MIN)}	Vfb = GND, V _{CC} = 10V				
	I _{OP(MAX)}	Vfb = GND, V _{CC} = 28V				

Note:

1. These parameters is the current flowing in the Control IC.
2. These parameters, although guaranteed, are tested in EDS(wafer test) process.
3. These parameters indicate Inductor Current.

Typical Performance Characteristics

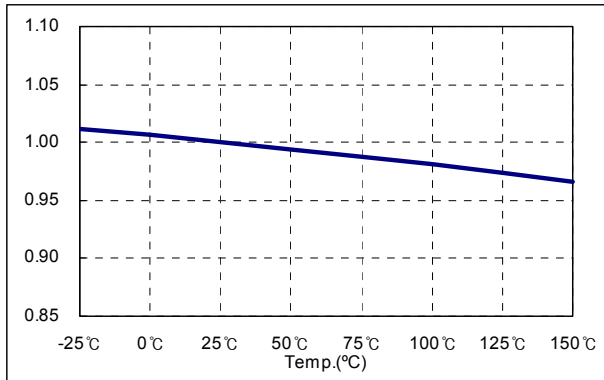

Figure 1. Start Voltage

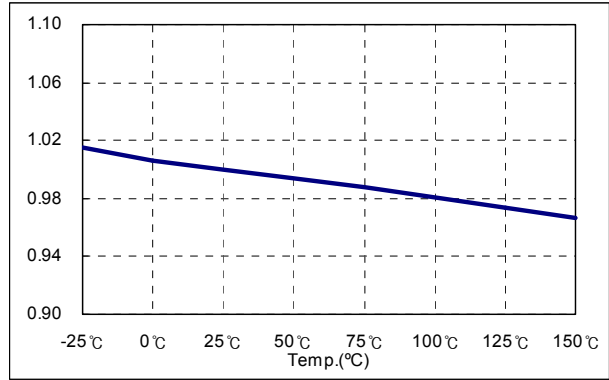

Figure 2. Stop Voltage

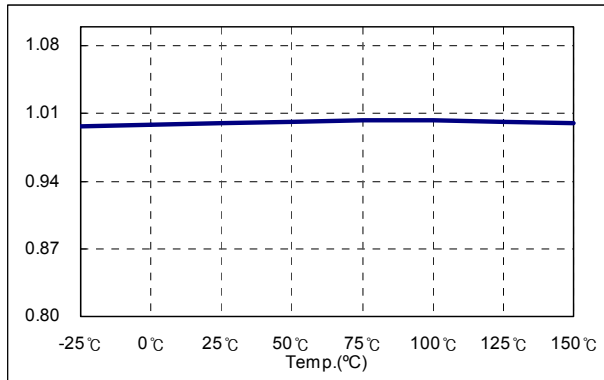

Figure 3. Stand by Current

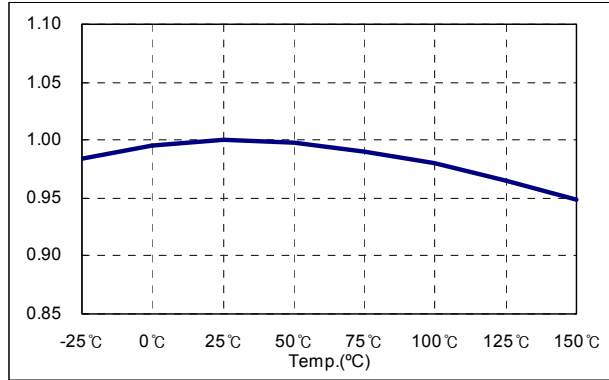

Figure 4. Operating Current

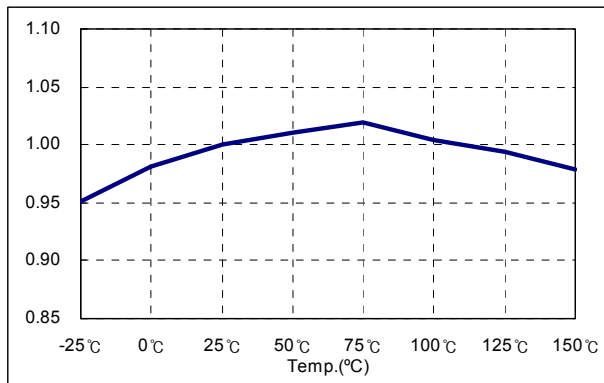

Figure 5. Initial Frequency

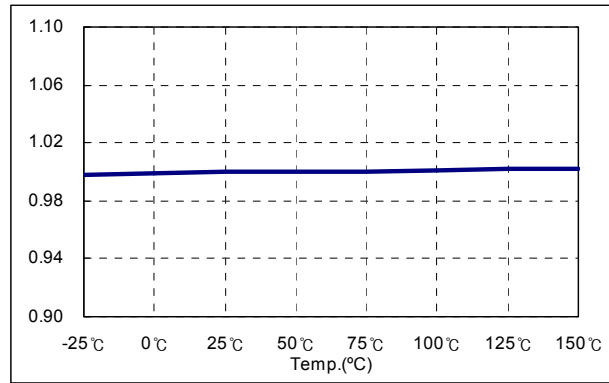

Figure 6. Maximum Duty

Typical Performance Characteristics (Continued)

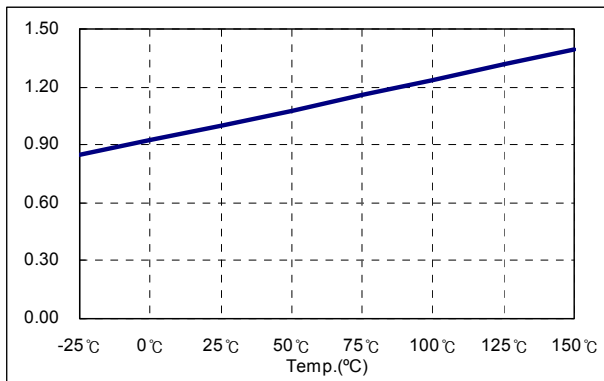

Figure 7. Feedback Offset Voltage

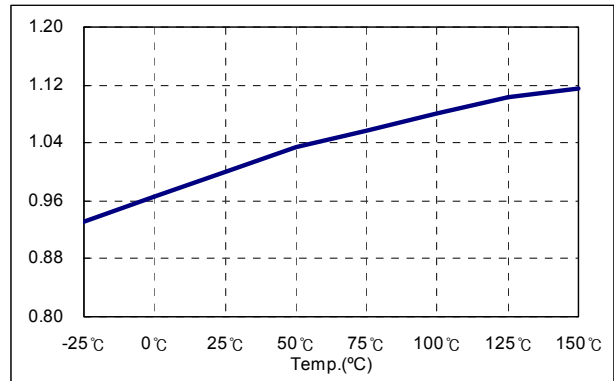

Figure 8. Feedback Source Current

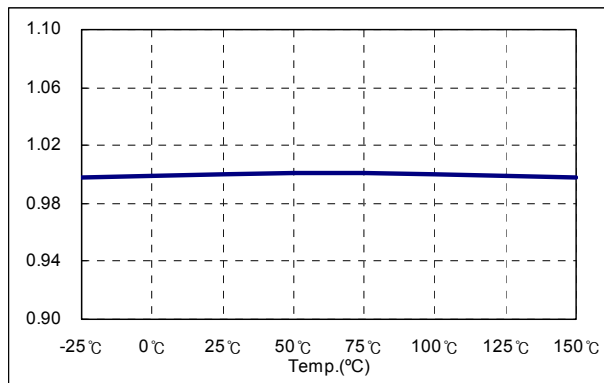

Figure 9. Over Voltage Protection

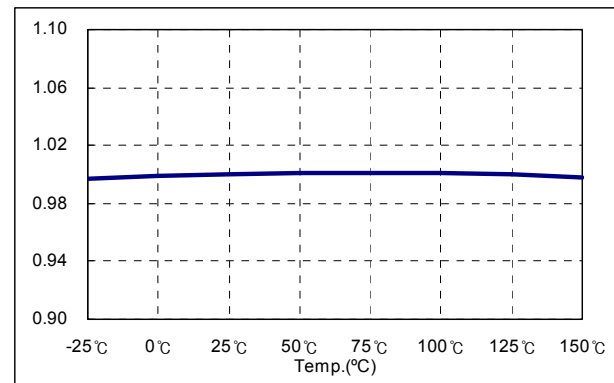

Figure 10. Shutdown Feedback Voltage

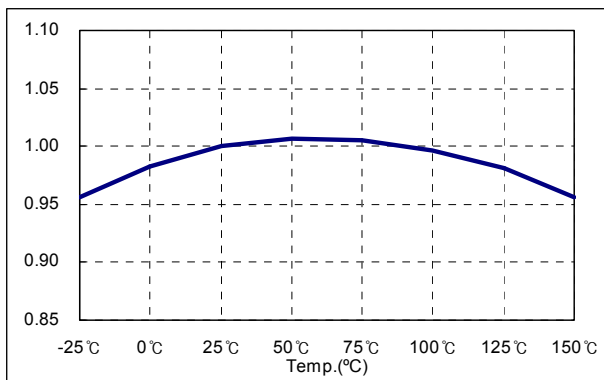

Figure 11. ShutDown Delay Current

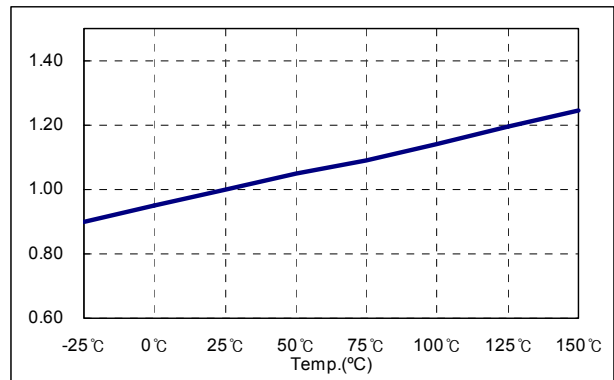

Figure 12. Burst Mode Enable Feedback Voltage

Typical Performance Characteristics (Continued)

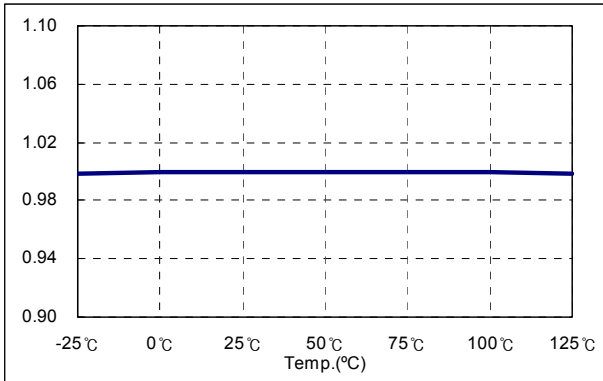

Figure 13. Burst Mode Low Threshold Voltage

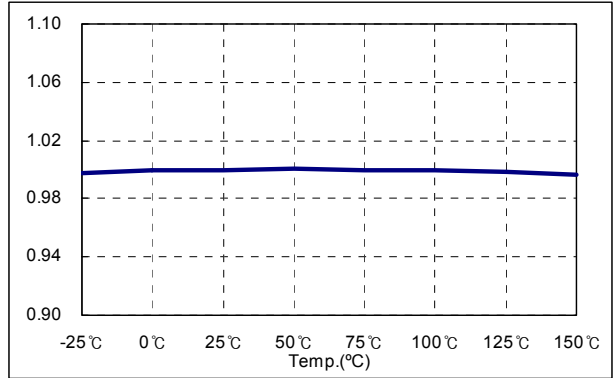

Figure 14. Burst Mode High Threshold Voltage

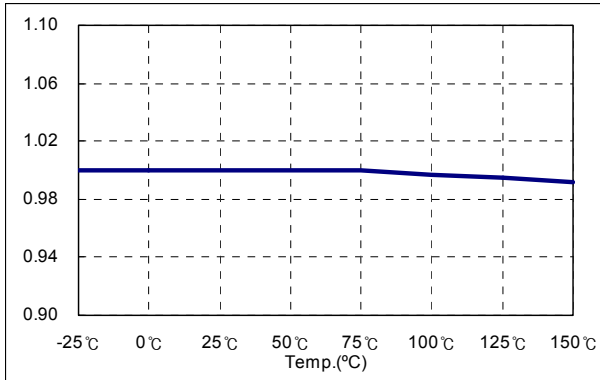

Figure 15. Burst Mode Sync. High Threshold Voltage

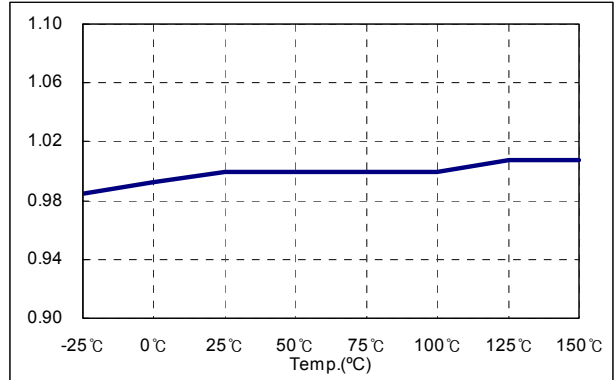

Figure 16. Burst Mode Sync. Low Threshold Voltage

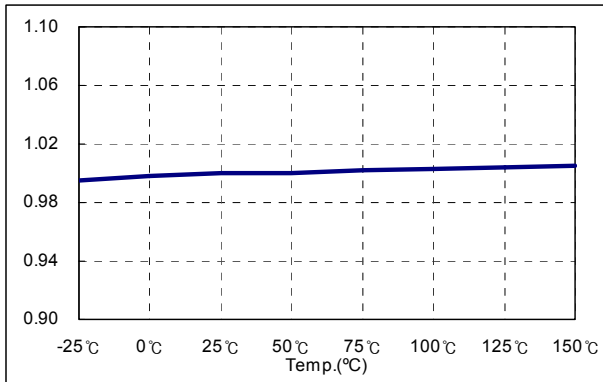

Figure 17. Primary Voltage

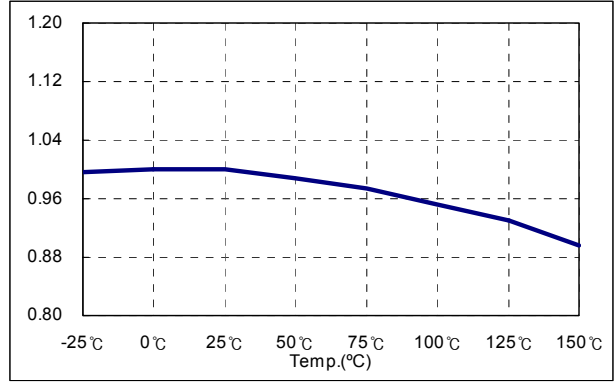

Figure 18. Primary Mode Gain

Typical Performance Characteristics (Continued)

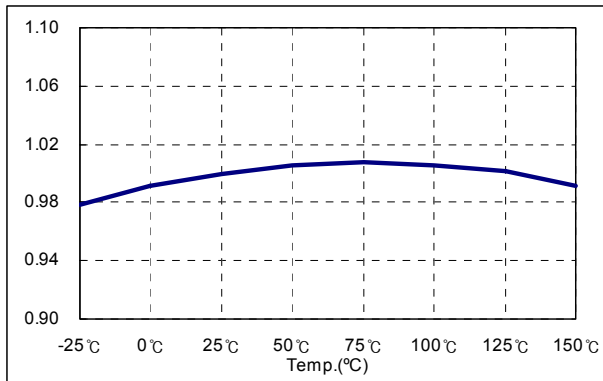

Figure 19. Peak Current Limit

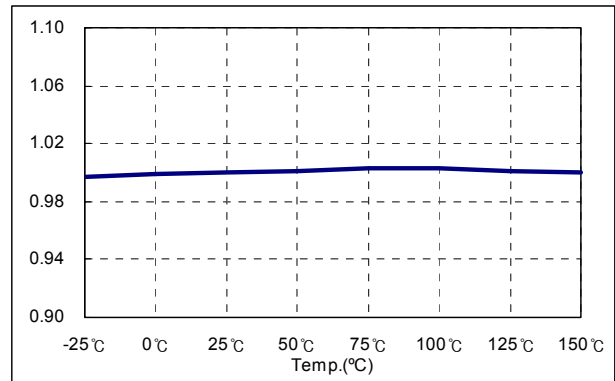

Figure 20. Burst Mode Peak Current Limit

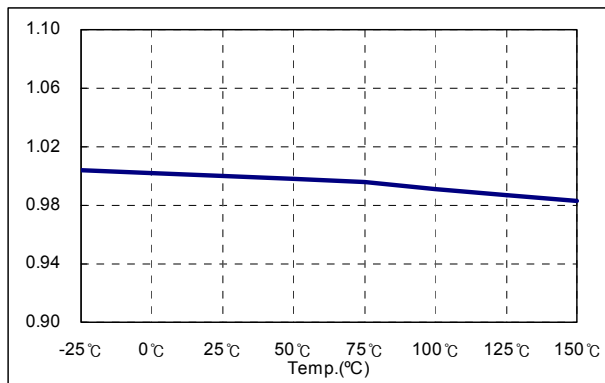

Figure 21. Normal Mode Sync. High Threshold Voltage

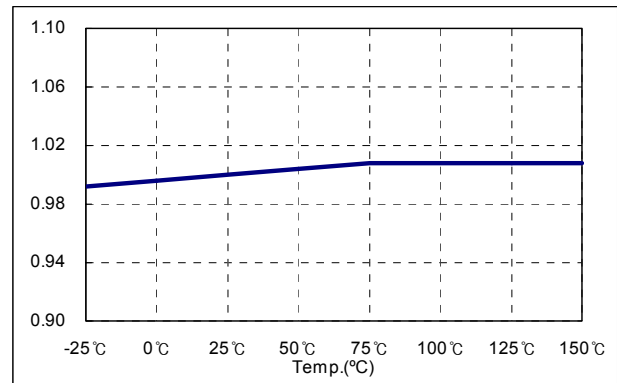

Figure 21. Normal Mode Sync. Low Threshold Voltage

Typical Performance Characteristics (MOSFET Part)

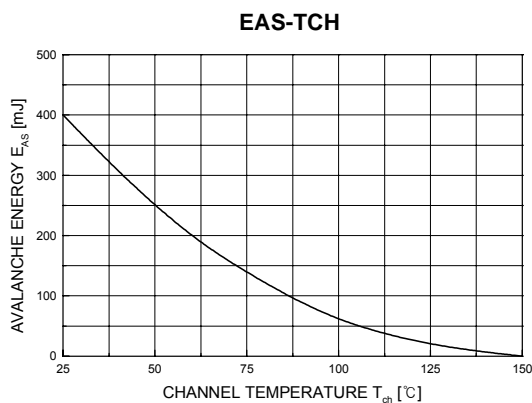

Figure 22. Temperature (T_C) vs. Eas Curve

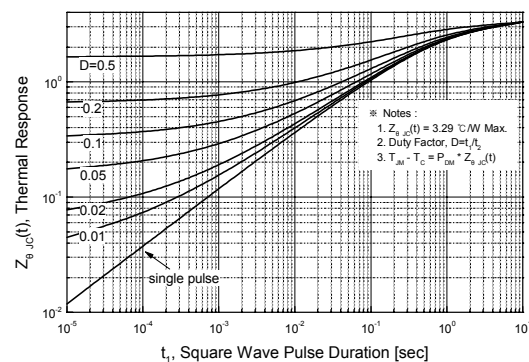
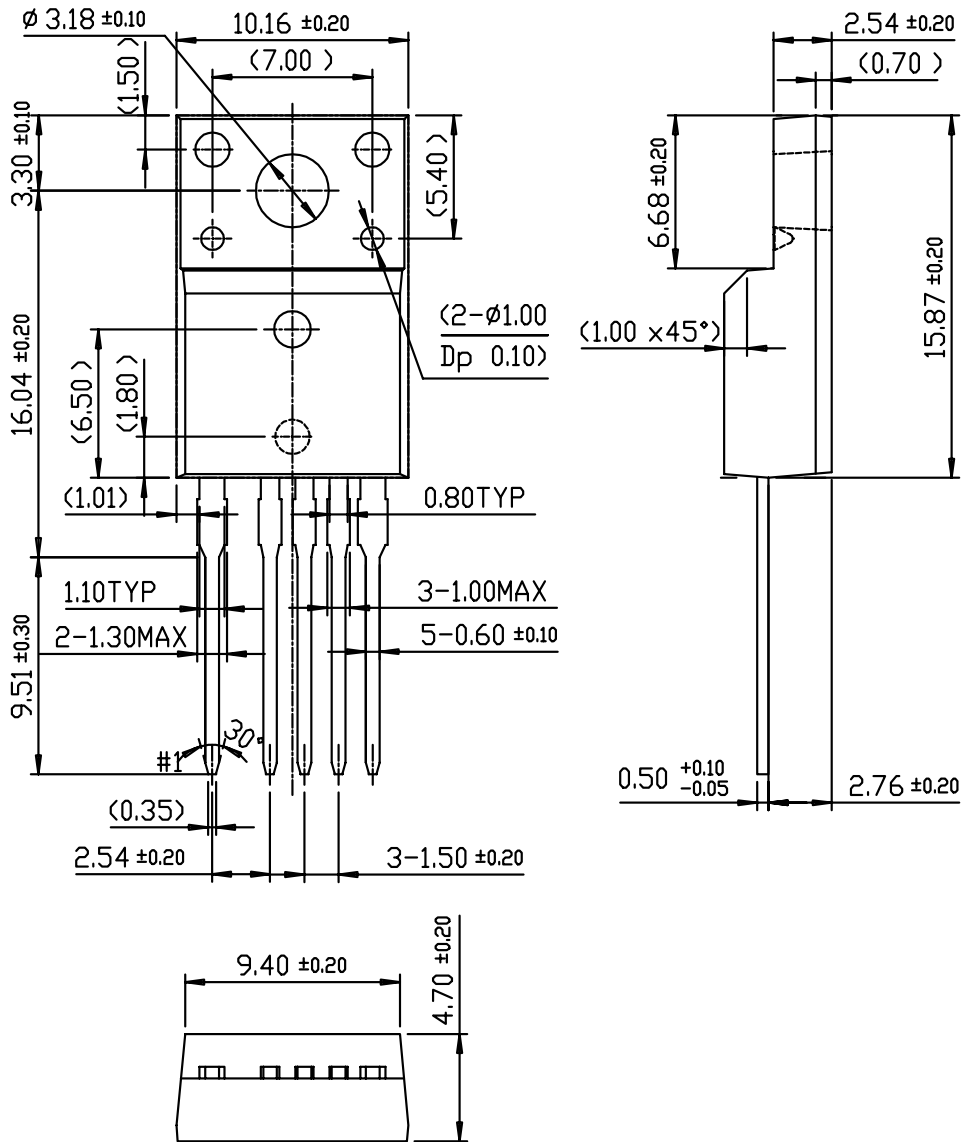

Figure 23. Transient Thermal Response Curve

Package Dimensions

TO-220F-5L



Ordering Information

Product Number	Package	Operating Temp.
KA5Q0565RTTU	TO-220F-5L	-25°C to +85°C
KA5Q0565RTYDTU	TO-220F-5L(Forming)	

TU : Non Forming Type

YDTU : Forming Type

DISCLAIMER

FAIRCHILD SEMICONDUCTOR RESERVES THE RIGHT TO MAKE CHANGES WITHOUT FURTHER NOTICE TO ANY PRODUCTS HEREIN TO IMPROVE RELIABILITY, FUNCTION OR DESIGN. FAIRCHILD DOES NOT ASSUME ANY LIABILITY ARISING OUT OF THE APPLICATION OR USE OF ANY PRODUCT OR CIRCUIT DESCRIBED HEREIN; NEITHER DOES IT CONVEY ANY LICENSE UNDER ITS PATENT RIGHTS, NOR THE RIGHTS OF OTHERS.

LIFE SUPPORT POLICY

FAIRCHILD'S PRODUCTS ARE NOT AUTHORIZED FOR USE AS CRITICAL COMPONENTS IN LIFE SUPPORT DEVICES OR SYSTEMS WITHOUT THE EXPRESS WRITTEN APPROVAL OF THE PRESIDENT OF FAIRCHILD SEMICONDUCTOR CORPORATION. As used herein:

1. Life support devices or systems are devices or systems which, (a) are intended for surgical implant into the body, or (b) support or sustain life, and (c) whose failure to perform when properly used in accordance with instructions for use provided in the labeling, can be reasonably expected to result in a significant injury of the user.
2. A critical component in any component of a life support device or system whose failure to perform can be reasonably expected to cause the failure of the life support device or system, or to affect its safety or effectiveness.