

KSA992

KSA992

Audio Frequency Low Noise Amplifier

- Complement to KSC1845

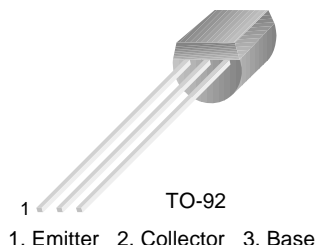

PNP Epitaxial Silicon Transistor

Absolute Maximum Ratings $T_a=25^\circ\text{C}$ unless otherwise noted

Symbol	Parameter	Ratings	Units
V_{CBO}	Collector-Base Voltage	-120	V
V_{CEO}	Collector-Emitter Voltage	-120	V
V_{EBO}	Emitter-Base Voltage	-5	V
I_C	Collector Current	-50	mA
I_B	Base Current	-10	mA
P_C	Collector Power Dissipation	500	mW
T_J	Junction Temperature	150	$^\circ\text{C}$
T_{STG}	Storage Temperature	-55 ~ 150	$^\circ\text{C}$

Electrical Characteristics $T_a=25^\circ\text{C}$ unless otherwise noted

Symbol	Parameter	Test Condition	Min.	Typ.	Max.	Units
I_{CBO}	Collector Cut-off Current	$V_{CB} = -120\text{V}, I_E = 0$			-50	nA
I_{CEO}	Collector Cur-off Current	$V_{CE} = -100\text{V}, I_B = 0$			-1	μA
I_{EBO}	Emitter Cut-off Current	$V_{EB} = -5\text{mA}, I_C = 0$			-50	nA
h_{FE1} h_{FE2}	DC Current Gain	$V_{CE} = -6\text{V}, I_C = -0.1\text{mA}$ $V_{CE} = -6\text{V}, I_C = -1\text{mA}$	150 200	500 500	800	
$V_{BE}(\text{on})$	Base-Emitter On Voltage	$V_{CE} = -6\text{V}, I_C = -1\text{mA}$	-0.55	-0.61	-0.65	V
$V_{CE}(\text{sat})$	Collector-Emitter Saturation Voltage	$I_C = -10\text{mA}, I_B = -1\text{mA}$		-0.09	-0.3	V
f_T	Current Gain Bandwidth Product	$V_{CE} = -6\text{V}, I_C = -1\text{mA}$	50	100		MHz
C_{ob}	Output Capacitance	$V_{CB} = -30\text{V}, I_E = 0, f = 1\text{MHz}$		2	3	pF
NV	Noise Voltage	$V_{CE} = -5.0\text{V}, I_C = -1.0\text{mA},$ $R_G = 100\text{KW}, G_V = 80\text{dB},$ $f = 10\text{Hz to } 1.0\text{KHz}$		25	40	mV

h_{FE2} Classification

Classification	P	F	E
h_{FE2}	200 ~ 400	300 ~ 600	400 ~ 800

Typical Characteristics

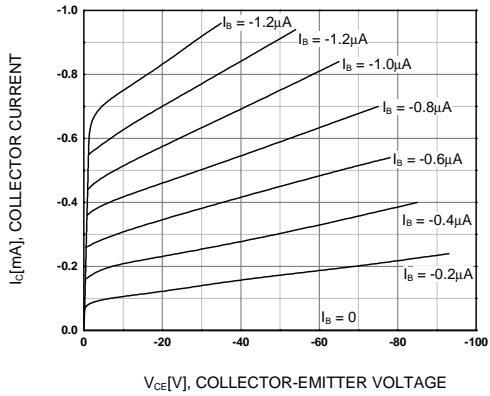

Figure 1. Static Characteristic

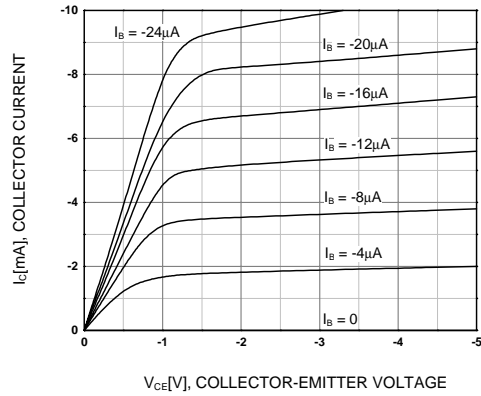

Figure 2. Static Characteristic

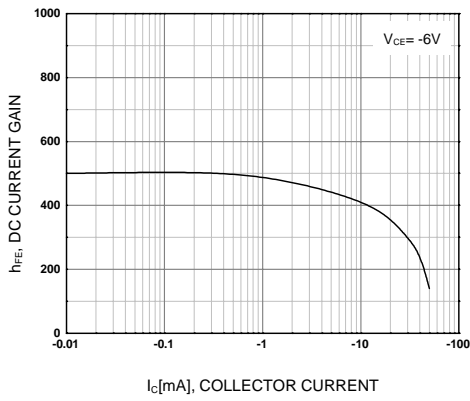

Figure 3. DC current Gain

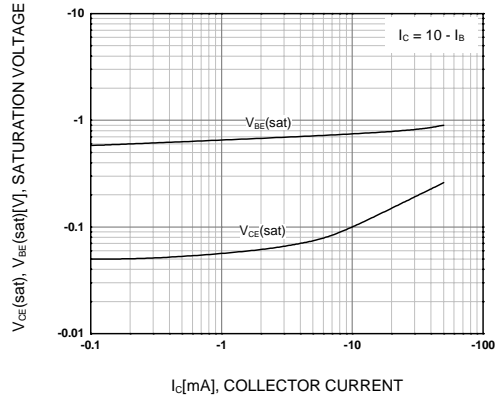

Figure 4. Base-Emitter Saturation Voltage
Collector-Emitter Saturation Voltage

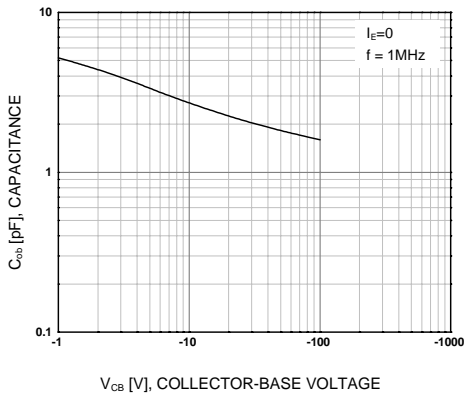

Figure 5. Collector Output Capacitance

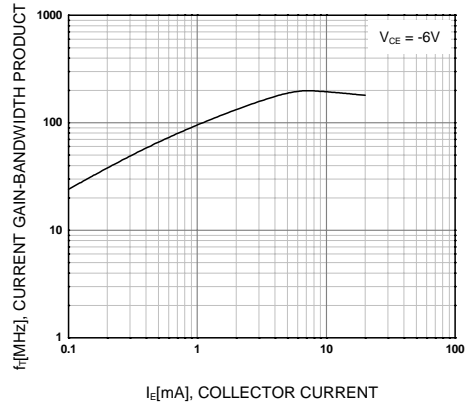

Figure 6. Current Gain Bandwidth Product

Typical Characteristics (Continued)

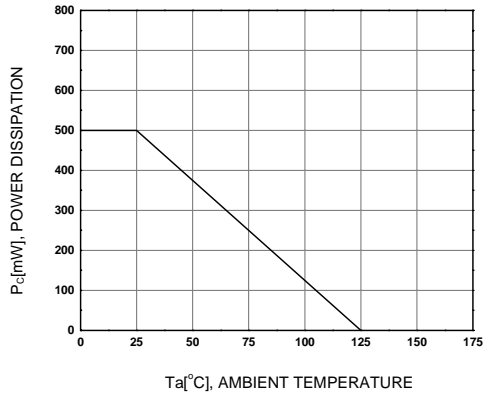
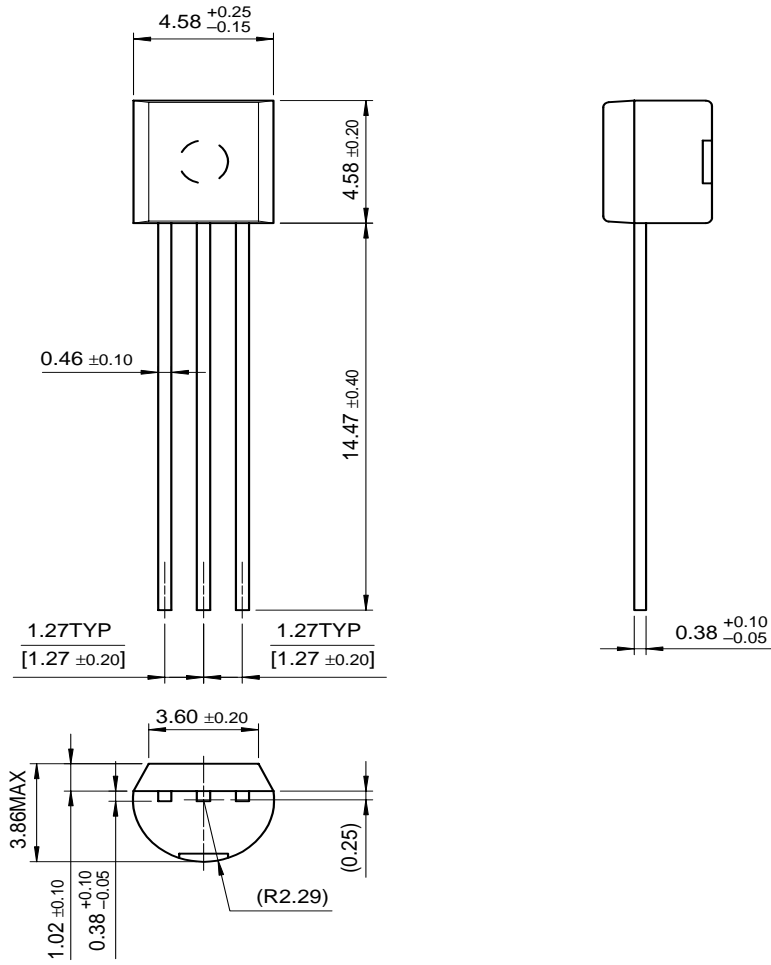

Figure 7. Power Derating

Package Dimensions

TO-92



Dimensions in Millimeters

TRADEMARKS

The following are registered and unregistered trademarks Fairchild Semiconductor owns or is authorized to use and is not intended to be an exhaustive list of all such trademarks.

ACE _x TM	FAST [®]	ISOPLANAR TM	Power247 TM	SuperFET TM
ActiveArray TM	FAST _r TM	LittleFET TM	PowerSaver TM	SuperSOT TM -3
Bottomless TM	FPS TM	MICROCOUPLER TM	PowerTrench [®]	SuperSOT TM -6
CoolFET TM	FRFET TM	MicroFET TM	QFET [®]	SuperSOT TM -8
CROSSVOLT TM	GlobalOptoisolator TM	MicroPak TM	QS TM	SyncFET TM
DO _M E TM	GTO TM	MICROWIRE TM	QT Optoelectronics TM	TinyLogic [®]
EcoSPARK TM	HiSeC TM	MSX TM	Quiet Series TM	TINYOPTO TM
E ² CMOS TM	I ² C TM	MSXPro TM	RapidConfigure TM	TruTranslation TM
EnSigna TM	i-Lo TM	OCX TM	RapidConnect TM	UHC TM
FACT TM	ImpliedDisconnect TM	OCXPro TM	μSerDes TM	UltraFET [®]
FACT Quiet Series TM		OPTOLOGIC [®]	SILENT SWITCHER [®]	VCX TM
Across the board. Around the world. TM		OPTOPLANAR TM	SMART START TM	
The Power Franchise [®]		PACMAN TM	SPM TM	
Programmable Active Droop TM		POP TM	Stealth TM	

DISCLAIMER

FAIRCHILD SEMICONDUCTOR RESERVES THE RIGHT TO MAKE CHANGES WITHOUT FURTHER NOTICE TO ANY PRODUCTS HEREIN TO IMPROVE RELIABILITY, FUNCTION OR DESIGN. FAIRCHILD DOES NOT ASSUME ANY LIABILITY ARISING OUT OF THE APPLICATION OR USE OF ANY PRODUCT OR CIRCUIT DESCRIBED HEREIN; NEITHER DOES IT CONVEY ANY LICENSE UNDER ITS PATENT RIGHTS, NOR THE RIGHTS OF OTHERS.

LIFE SUPPORT POLICY

FAIRCHILD'S PRODUCTS ARE NOT AUTHORIZED FOR USE AS CRITICAL COMPONENTS IN LIFE SUPPORT DEVICES OR SYSTEMS WITHOUT THE EXPRESS WRITTEN APPROVAL OF FAIRCHILD SEMICONDUCTOR CORPORATION.

As used herein:

1. Life support devices or systems are devices or systems which, (a) are intended for surgical implant into the body, or (b) support or sustain life, or (c) whose failure to perform when properly used in accordance with instructions for use provided in the labeling, can be reasonably expected to result in significant injury to the user.
2. A critical component is any component of a life support device or system whose failure to perform can be reasonably expected to cause the failure of the life support device or system, or to affect its safety or effectiveness.

PRODUCT STATUS DEFINITIONS

Definition of Terms

Datasheet Identification	Product Status	Definition
Advance Information	Formative or In Design	This datasheet contains the design specifications for product development. Specifications may change in any manner without notice.
Preliminary	First Production	This datasheet contains preliminary data, and supplementary data will be published at a later date. Fairchild Semiconductor reserves the right to make changes at any time without notice in order to improve design.
No Identification Needed	Full Production	This datasheet contains final specifications. Fairchild Semiconductor reserves the right to make changes at any time without notice in order to improve design.
Obsolete	Not In Production	This datasheet contains specifications on a product that has been discontinued by Fairchild semiconductor. The datasheet is printed for reference information only.