



LUXEON Rebel  
General Purpose White  
Portfolio

*High flux  
and color stability*

Technical Datasheet DS64

L U X E N<sup>®</sup>  
never before possible

# LUXEON<sup>®</sup> Rebel

## General Purpose White Portfolio

### Introduction

The LUXEON<sup>®</sup> Rebel General Purpose White Portfolio LEDs in this datasheet are ideal for all lighting and illumination applications. These flux differentiated parts, like all other LUXEON Rebel LEDs, provide the industry's best lumen maintenance, superior reliability and quality white light that make them the most widely used power LEDs today. Using the information in this document you can start designing applications to your unique specifications.

LUXEON Rebel General Purpose White LEDs

- Deliver more usable light and higher flux density
- Optimize applications to reduce size and cost
- Tightly pack the LEDs for mixing
- Engineer more robust applications
- Utilize standard FR4 PCB technology
- Simplify manufacturing through the use of surface mount technology.

**PHILIPS**  
**LUMILEDS**

# Table of Contents

Product Nomenclature.....	3
Average Lumen Maintenance Characteristics .....	3
Environmental Compliance.....	3
Visual Appearance of LUXEON Rebel.....	3
Flux Characteristics.....	4
Flux Performance, Binning, and Supportability .....	5
Optical Characteristics.....	6
Electrical Characteristics.....	7
Absolute Maximum Ratings .....	8
JEDEC Moisture Sensitivity.....	8
Reflow Soldering Characteristics .....	9
Mechanical Dimensions .....	10
Pad Configuration .....	11
Solder Pad Design.....	11
Wavelength Characteristics.....	12
Typical Light Output Characteristics over Temperature.....	14
Typical Forward Current Characteristics.....	15
Typical Relative Luminous Flux .....	16
Current Derating Curves.....	17
Typical Radiation Patterns.....	19
Emitter Pocket Tape Packaging.....	21
Emitter Reel Packaging .....	22
Product Binning and Labeling.....	23
Luminous Flux Bins.....	24
Cool-White Bin Structure .....	25
Neutral-White Bin Structure .....	27
Warm-White Bin Structure.....	28
Forward Voltage Bins.....	30

## Product Nomenclature

LUXEON Rebel is tested and binned at 350 mA.

The part number designation is explained as follows:

L X M L - A B C D - E F G H

Where:

- A — designates radiation pattern (value P for Lambertian)
- B — designates color (see LUXEON Rebel Binning and Labeling section)
- C — designates color variant (0 for direct colored variants)
- D — designates test current (value I for 350 mA)
- E — reserved for future product offerings
- FGH — minimum luminous flux (lm) or radiometric power (mW) performance

Therefore products tested and binned at 350 mA follow the part numbering scheme:

L X M L - P x 0 I - x x x x

## Average Lumen Maintenance Characteristics

Lifetime for solid-state lighting devices (LEDs) is typically defined in terms of lumen maintenance—the percentage of initial light output remaining after a specified period of time.

Philips Lumileds projects that cool-white, neutral-white and warm-white LUXEON Rebel products will deliver, on average, 70% lumen maintenance (B50, L70) at 50,000 hours of operation at a forward current of 700 mA. This projection is based on constant current operation with junction temperature maintained at or below 135°C.

This performance is based on independent test data, Philips Lumileds historical data from tests run on similar material systems, and internal LUXEON reliability testing. Observation of design limits included in this data sheet is required in order to achieve this projected lumen maintenance.

## Environmental Compliance

Philips Lumileds is committed to providing environmentally friendly products to the solid-state lighting market. LUXEON Rebel is compliant to the European Union directives on the restriction of hazardous substances in electronic equipment, namely the RoHS directive. Philips Lumileds will not intentionally add the following restricted materials to the LUXEON Rebel: lead, mercury, cadmium, hexavalent chromium, polybrominated biphenyls (PBB) or polybrominated diphenyl ethers (PBDE).

## Visual Appearance of LUXEON Rebel

All lighted LUXEON Rebel product will provide comparable lambertian beam performance, suitable for use with commercially available optical systems. Without power, LED die within different reels may appear visually different. Please contact your Philips Lumileds or Future Electronics representative for further information.

# Flux Characteristics

## Flux Characteristics for LUXEON Rebel, Thermal Pad Temperature=25°C

**Table I.**

Performance at Test Current				Typical Performance at Indicated Current	
Color	Part Number	Minimum Luminous Flux (lm) $\Phi_v$ [1]	Test Current (mA)	Typical Luminous Flux (lm) $\Phi_v$ [2]	Drive Current (mA)
Cool White	LXML-PWCI-0040	40	350	80	700
	LXML-PWCI-0050	50	350	95	700
	LXML-PWCI-0080	80	350	145	700
	LXML-PWCI-0090	90	350	160	700
	LXML-PWCI-0100	100	350	180	700
Neutral-White	LXML-PWNI-0040	40	350	80	700
	LXML-PWNI-0050	50	350	95	700
	LXML-PWNI-0080	80	350	145	700
	LXML-PWNI-0090	90	350	160	700
	LXML-PWNI-0100	100	350	180	700
Warm-White	LXML-PWWI-0040	40	350	80	700
	LXML-PWWI-0050	50	350	95	700
	LXML-PWWI-0060	60	350	110	700

**Notes for Table I:**

1. Minimum luminous flux performance guaranteed within published operating conditions. Philips Lumileds maintains a tolerance of  $\pm 6.5\%$  on flux measurements.
2. Typical luminous flux performance when device is operated within published operating conditions.

# Flux Characteristics, Continued

## Flux Performance, Binning, and Supportability

LEDs are produced with semiconductor technology that is subject to process variation, yielding a range of flux performance that is approximately Gaussian in nature. In order to provide customers with fine granularity within the overall flux distribution, Philips Lumileds separates LEDs into fixed, easy to design with, minimum luminous flux bins. To verify supportability of parts chosen for your application design, please consult your Philips Lumileds/Future Lighting Solutions sales representative.

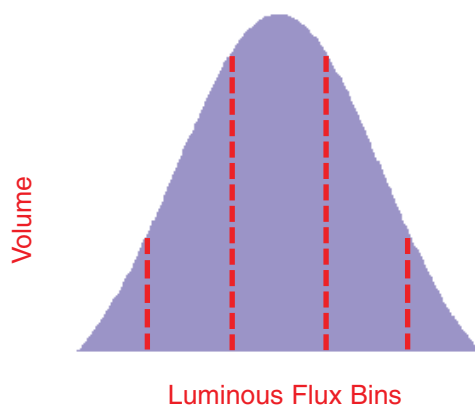

# Optical Characteristics

## Lambertian LUXEON Rebel at Test Current <sup>[1]</sup> Thermal Pad Temperature = 25°C

**Table 2.**

Color	Color Temperature <sup>[3] [4]</sup> CCT			Typical Total Included Angle <sup>[5]</sup> (degrees) $\theta_{0.90V}$	Typical Viewing Angle <sup>[6]</sup> (degrees) 2 $\theta$ 1/2
	Min.	Typ.	Max.		
Cool-White	4500K	6500K	10,000K	160	120
Neutral-White	3500K	4100K	4500K	160	120
Warm-White	2540K	3100K	3500K	160	120

Notes for Table 2:

1. Test current is 350 mA for all LXML-PxxI-0xxx products.
2. CCT  $\pm 5\%$  tester tolerance.
3. Typical CRI (Color Rendering Index) for cool-white is 70, neutral-white is 70 and warm-white is 85.
4. Total angle at which 90% of total luminous flux is captured.
5. Viewing angle is the off axis angle from lamp centerline where the luminous intensity is  $\frac{1}{2}$  of the peak value.
6. All white products are built with Indium Gallium Nitride (InGaN).
7. Cool-white, neutral-white and warm-white power light sources represented here are IEC825 class 2 for eye safety.

# Electrical Characteristics

## Electrical Characteristics at 350 mA for LUXEON Rebel, Part Numbers LXML-Pxx I-0xxx, Thermal Pad Temperature = 25°C

**Table 3.**

Color	Forward Voltage $V_f$ <sup>[1]</sup> (V)			Typical Temperature Coefficient of Forward Voltage <sup>[2]</sup> (mV/°C) $\Delta V_f / \Delta T_j$	Typical Thermal Resistance Junction to Thermal Pad (°C/W) $R\theta_{j-c}$
	Min.	Typ.	Max.		
Cool-White	2.55	3.15	3.99	-2.0 to -4.0	10
Neutral-White	2.55	3.15	3.99	-2.0 to -4.0	10
Warm-White	2.55	3.15	3.99	-2.0 to -4.0	10

Notes for Table 3:

1. Philips Lumileds maintains a tolerance of  $\pm 0.06V$  on forward voltage measurements.
  2. Measured between  $25^\circ C = T_j = 110^\circ C$  at  $I_f = 350$  mA.
- \* Dynamic resistance is the inverse of the slope in linear forward voltage model for LEDs. See figure 6.

## Typical Electrical Characteristics at 700 mA for LUXEON Rebel, Part Numbers LXML-Pxx I-0xxx, Thermal Pad Temperature = 25°C

**Table 4.**

Color	Typical Forward Voltage $V_f$ (V)
Cool-White	3.40
Neutral-White	3.40
Warm-White	3.40

Notes for Table 4:

1. Philips Lumileds maintains a tolerance of  $\pm 0.06V$  on forward voltage measurements.
2. Dynamic resistance is the inverse of the slope in linear forward voltage model for LEDs. See figure 6.
3. Measured between  $25^\circ C = T_j = 110^\circ C$  at  $I_f = 700$  mA.

## Absolute Maximum Ratings

**Table 5.**

Parameter	Cool-White/Neutral-White/Warm-White
DC Forward Current (mA)	1000
Peak Pulsed Forward Current (mA)	1000
Average Forward Current (mA)	1000
ESD Sensitivity	< 8000V Human Body Model (HBM) Class 2 JESD22-A114-B < 400V Machine Model (MM) Class 2 JESD22-A115-B
LED Junction Temperature[1]	150°C
Operating Case Temperature at 350 mA	-40°C - 135°C
Storage Temperature	-40°C - 135°C
Soldering Temperature	JEDEC 020c 260°C
Allowable Reflow Cycles	3
Autoclave Conditions	121°C at 2 ATM 100% Relative Humidity for 96 Hours Maximum
Reverse Voltage (Vr)	See Note 2

**Notes for Table 5:**

1. Proper current derating must be observed to maintain junction temperature below the maximum.
2. LUXEON Rebel LEDs are not designed to be driven in reverse bias.

## JEDEC Moisture Sensitivity

**Table 6.**

Level	Soak Requirements			
	Floor Life		Standard	
	Time	Conditions	Time	Conditions
1	unlimited	≤ 30°C / 85% RH	168h + 5 / -0	85°C / 85% RH



# Reflow Soldering Characteristics

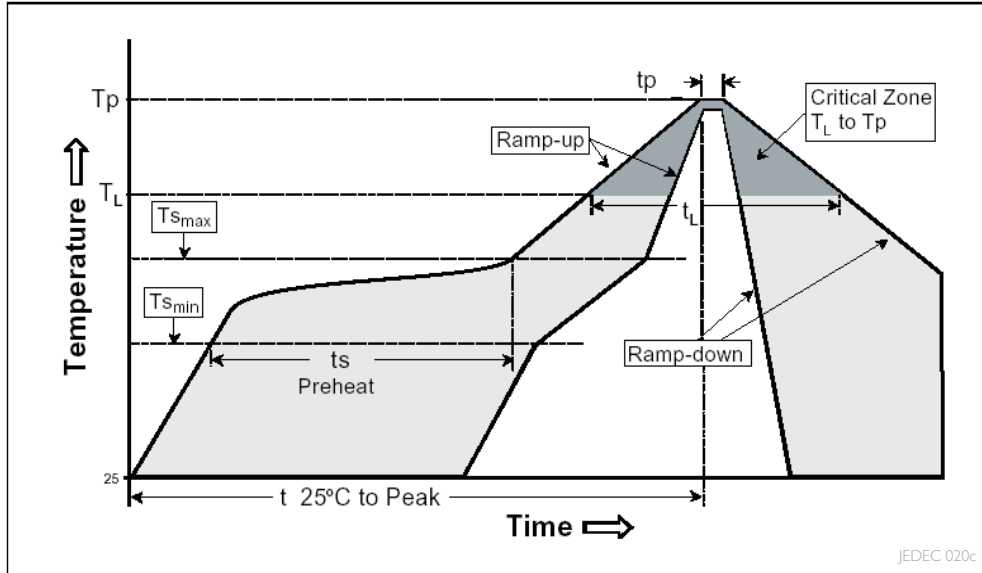

Table 7.

Profile Feature	Lead Free Assembly
Average Ramp-Up Rate ( $T_{s_{max}}$ to $T_p$ )	3°C / second max
Preheat Temperature Min ( $T_{s_{min}}$ )	150°C
Preheat Temperature Max ( $T_{s_{max}}$ )	200°C
Preheat Time ( $t_{s_{min}}$ to $t_{s_{max}}$ )	60 - 180 seconds
Time Maintained Above Temperature $T_L$ ( $t_L$ )	217°C
Time Maintained Above Time ( $t_L$ )	60 - 150 seconds
Peak / Classification Temperature ( $T_p$ )	260°C
Time Within 5°C of Actual Peak Temperature ( $t_p$ )	20 - 40 seconds
Ramp-Down Rate	6°C / second max
Time 25°C to Peak Temperature	8 minutes max

Note for Table 7:

- I. All temperatures refer to the application Printed Circuit Board (PCB), measured on the surface adjacent to the package body.

# Mechanical Dimensions

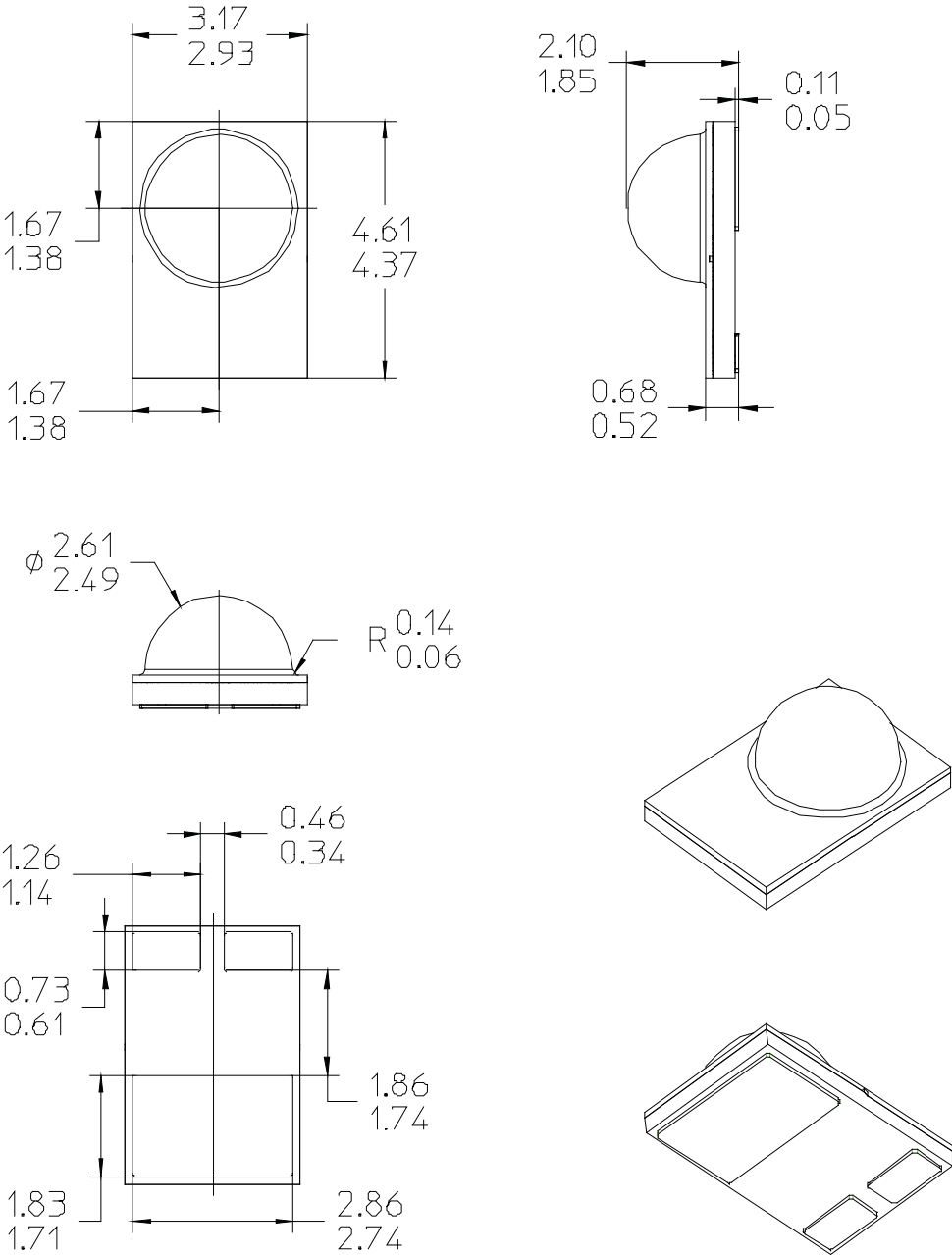
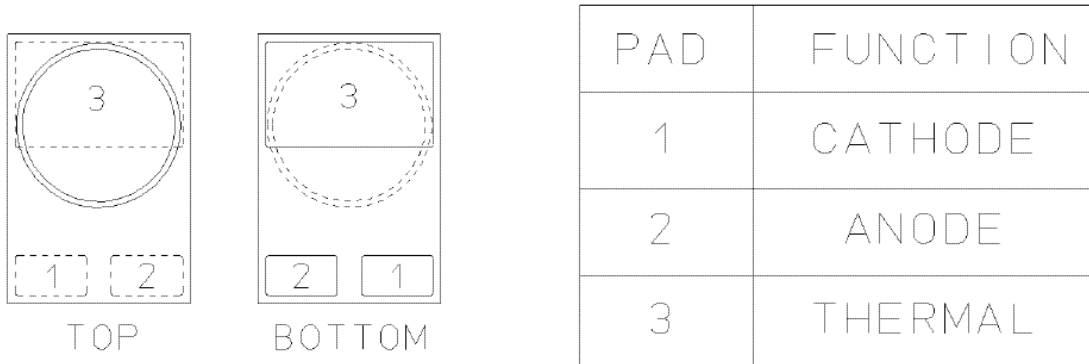

Figure I. Package outline drawing.

Notes for Figure I:

1. Do not handle the device by the lens—care must be taken to avoid damage to the lens or the interior of the device that can be damaged by excessive force to the lens.
2. Drawings not to scale.
3. All dimensions are in millimeters.
4. The Thermal Pad is electrically isolated from the Anode and Cathode contact pads.

# Pad Configuration



**Figure 2. Pad configuration.**

Note for Figure 2:

1. The Thermal Pad is electrically isolated from the Anode and Cathode contact pads.

## Solder Pad Design

Note for Figure 3:

The photograph below shows the recommended LUXEON Rebel layout on Printed Circuit Board (PCB). This design easily achieves a thermal resistance of 7K/W.

Application Brief AB32 provides extensive details for this layout. In addition, the .dwg files are available upon request.

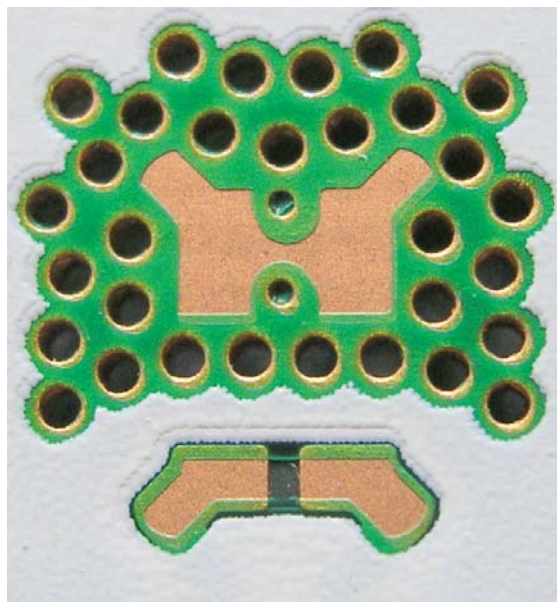

**Figure 3. Solder pad layout.**

# Wavelength Characteristics

## Cool-White at Test Current Thermal Pad Temperature = 25°C

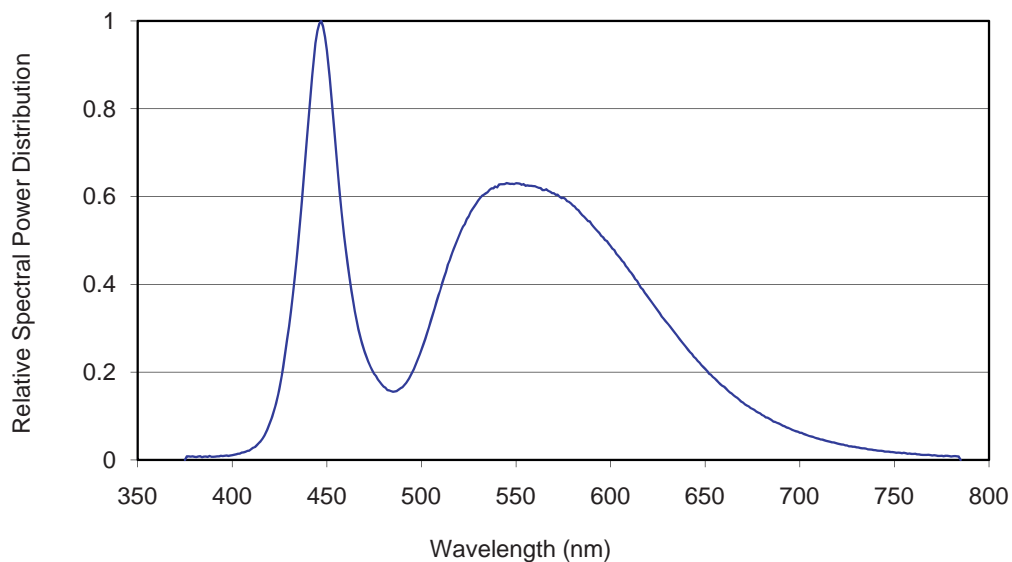

Figure 4a. Cool-white color spectrum of typical CCT part, integrated measurement

## Neutral-White at Test Current Thermal Pad Temperature = 25°C

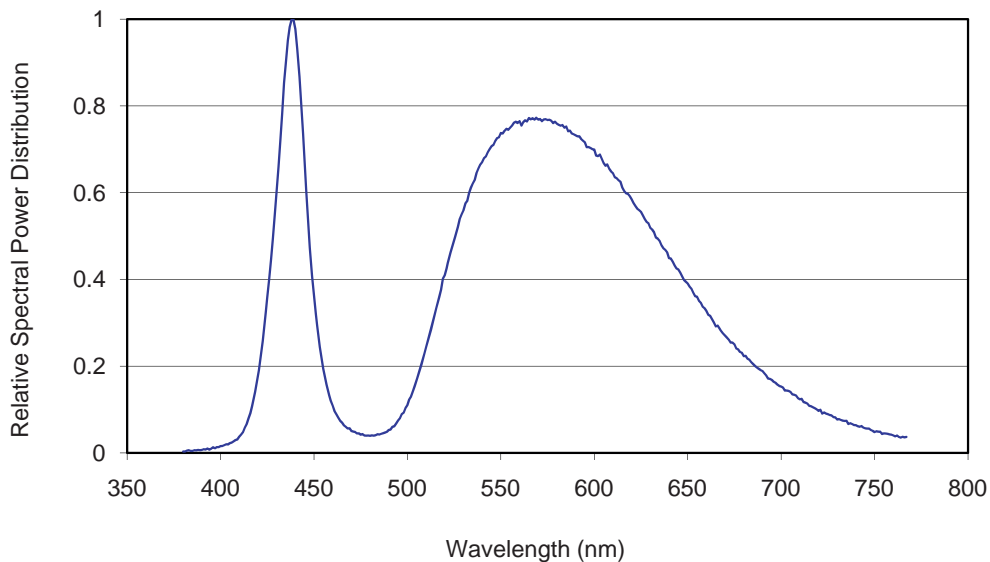

Figure 4b. Neutral-white color spectrum of typical CCT part, integrated measurement.

# Wavelength Characteristics, Continued

## Warm-White at Test Current

Thermal Pad Temperature = 25°C

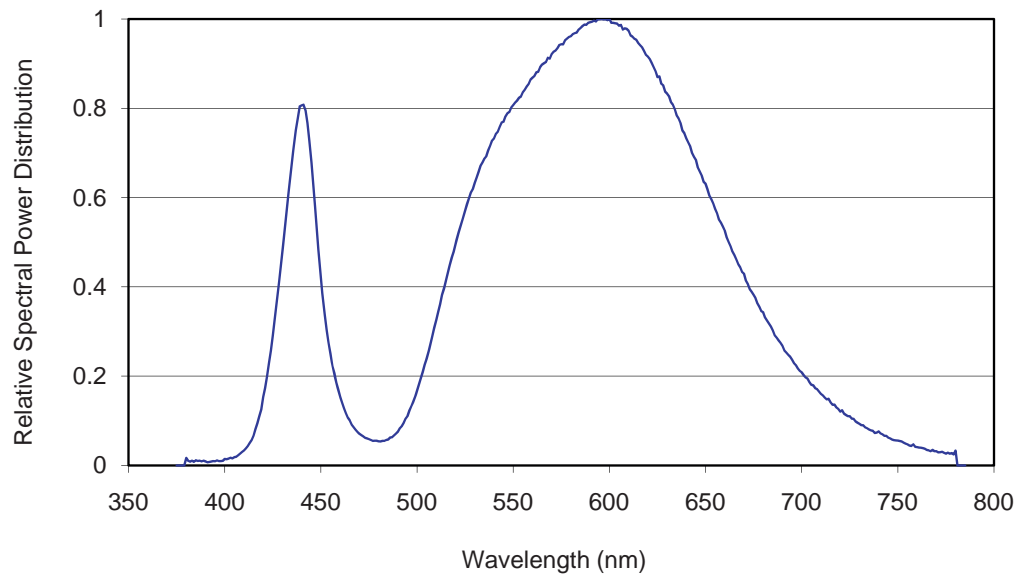
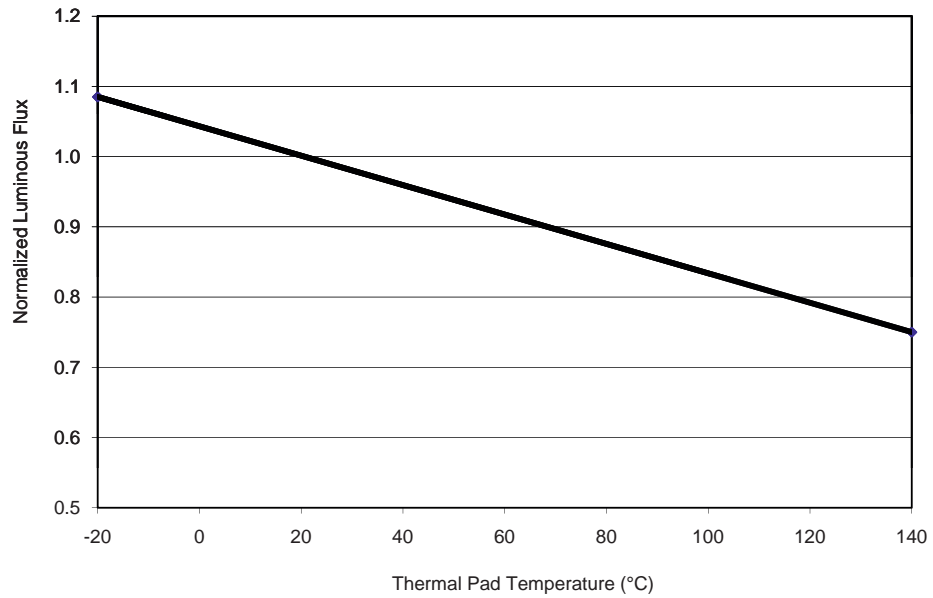

Figure 4c. Warm-white color spectrum of typical CCT part, integrated measurement.

# Typical Light Output Characteristics over Temperature

## Cool-White, Neutral-White, and Warm-White at Test Current



**Figure 5. Relative luminous flux vs. thermal pad temperature.**

# Typical Forward Current Characteristics

Cool-White, Neutral-White and Warm-White  
Thermal Pad Temperature = 25°C

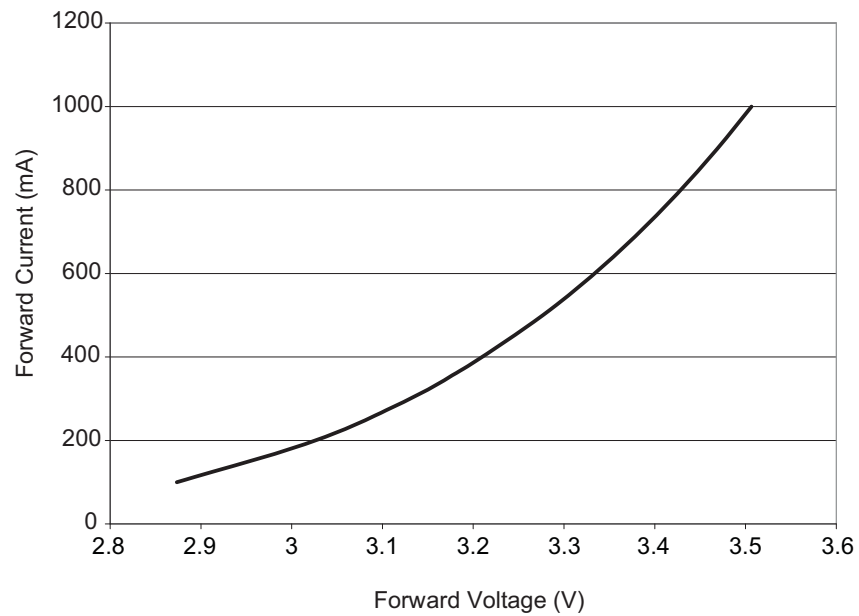
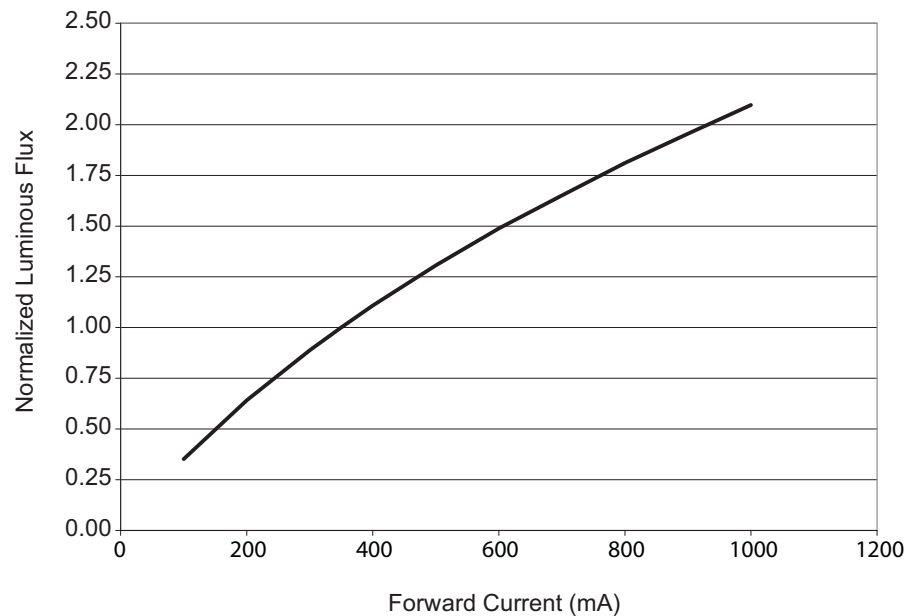

Figure 6. Forward current vs. forward voltage.

# Typical Relative Luminous Flux

## Typical Relative Luminous Flux vs. Forward Current for Cool-White, Neutral-White and Warm-White Thermal Pad Temperature = 25°C



**Figure 7. Relative luminous flux or radiometric power vs. forward current for cool-white, neutral-white and warm-white Thermal Pad = 25°C maintained, test current 350 mA.**



# Current Derating Curves

## Current Derating Curve for 350 mA Drive Current Cool-White, Neutral-White and Warm-White

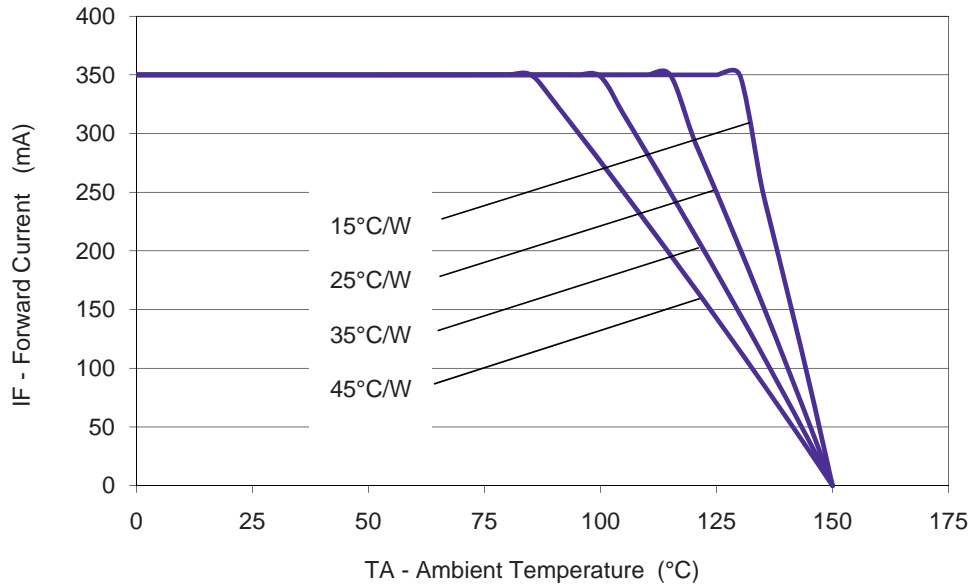

Figure 8. Maximum forward current vs. ambient temperature, based on  $T_{JMAX} = 150^{\circ}\text{C}$ .

## Current Derating Curve for 700 mA Drive Current Cool-White, Neutral-White and Warm-White

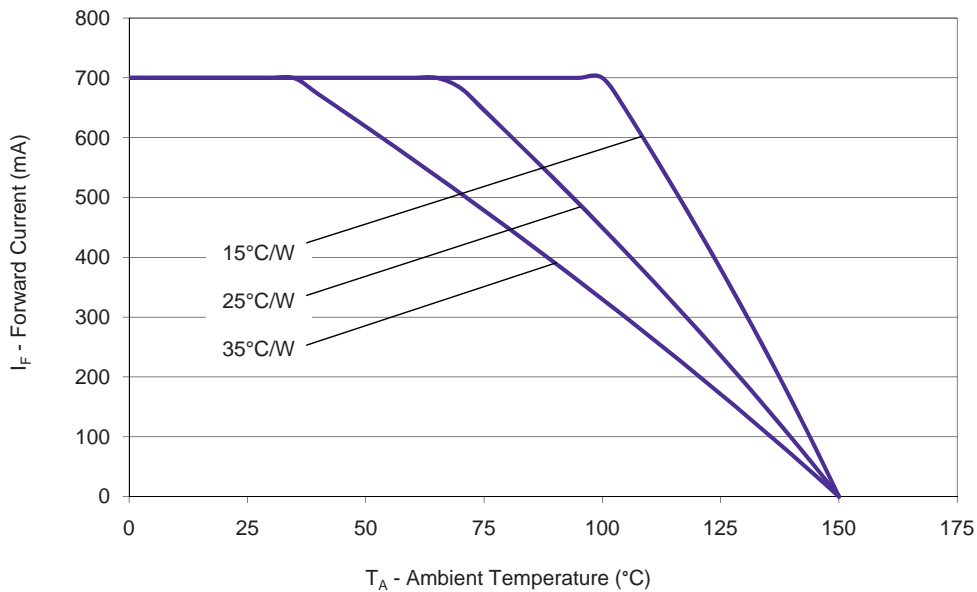

Figure 9. Maximum forward current vs. ambient temperature, based on  $T_{JMAX} = 150^{\circ}\text{C}$ .

I. Current derating curves represent constant current operation condition.

# Current Derating Curves, Continued

## Current Derating Curve for 1000 mA Drive Current Cool-White, Neutral-White and Warm-White

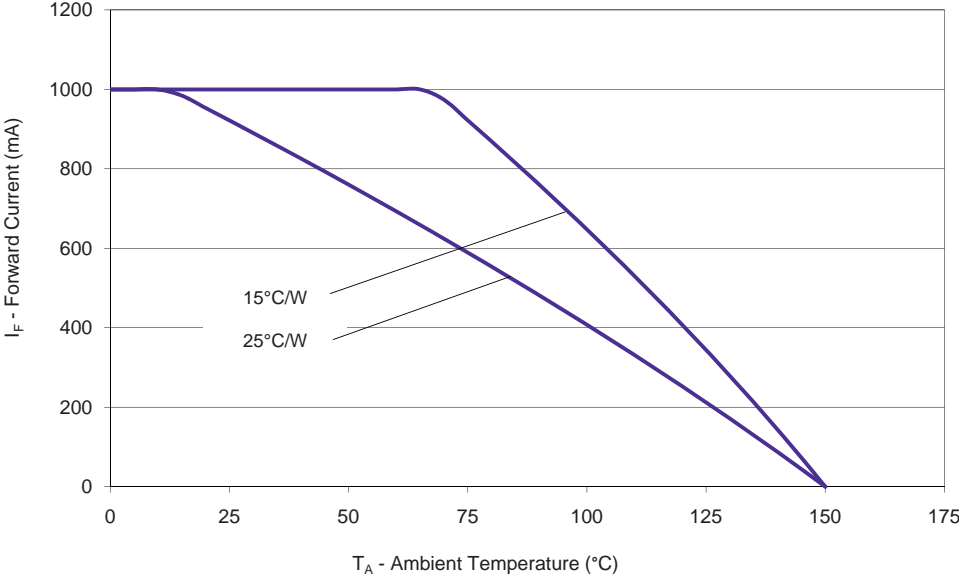

Figure 10. Maximum forward current vs. ambient temperature, based on  $T_{JMAX} = 150^\circ\text{C}$ .

# Typical Radiation Patterns

## Typical Spatial Radiation Pattern for Cool-White, Neutral-White and Warm-White Lambertian

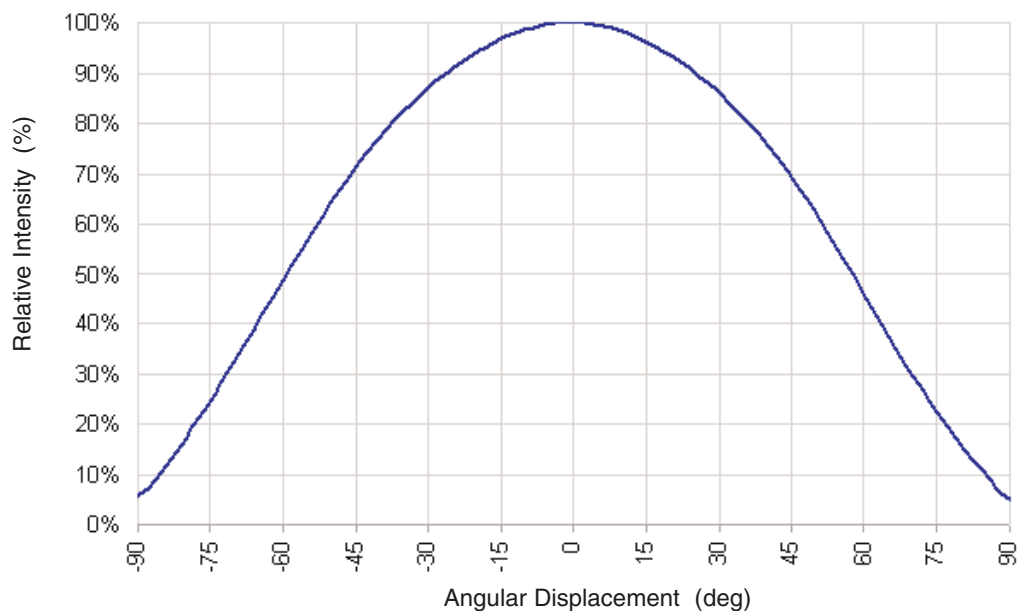

Figure 11a. Typical representative spatial radiation pattern for cool-white, neutral-white and warm-white lambertian.

## Typical Polar Radiation Pattern for White Lambertian

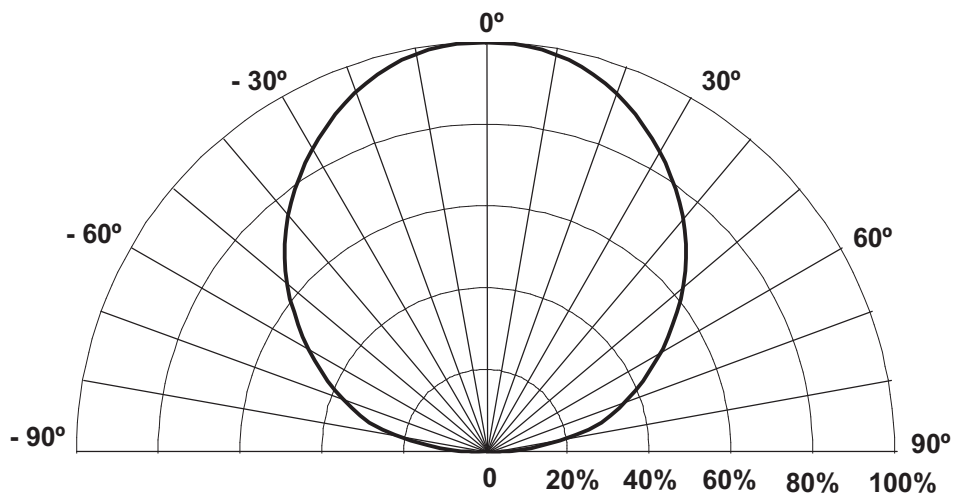

Figure 11b. Typical polar radiation pattern for cool-white, neutral-white and warm-white lambertian.

# Typical Radiation Patterns, Continued

## Typical Color Coordinates vs. Angle for Warm-White

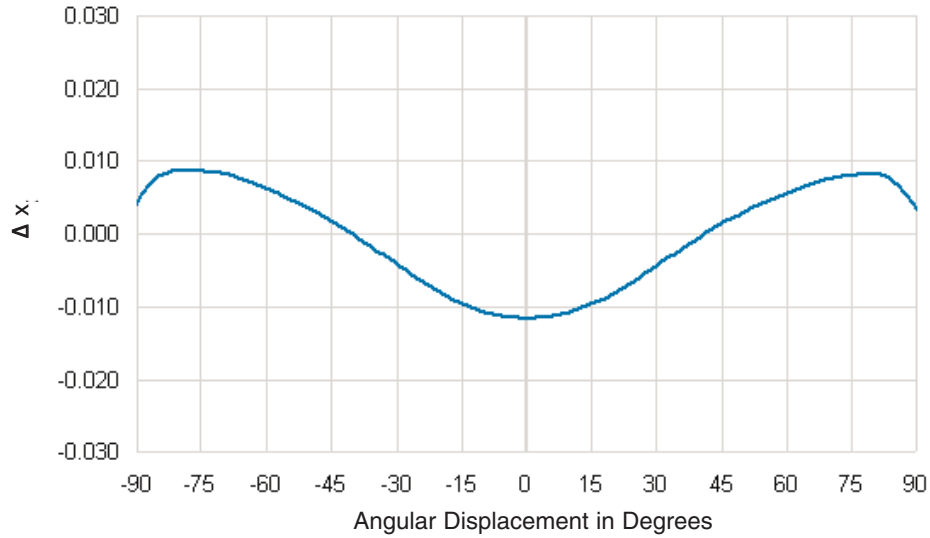

Figure 12a. X coordinate vs. angle for warm-white LUXEON Rebel.

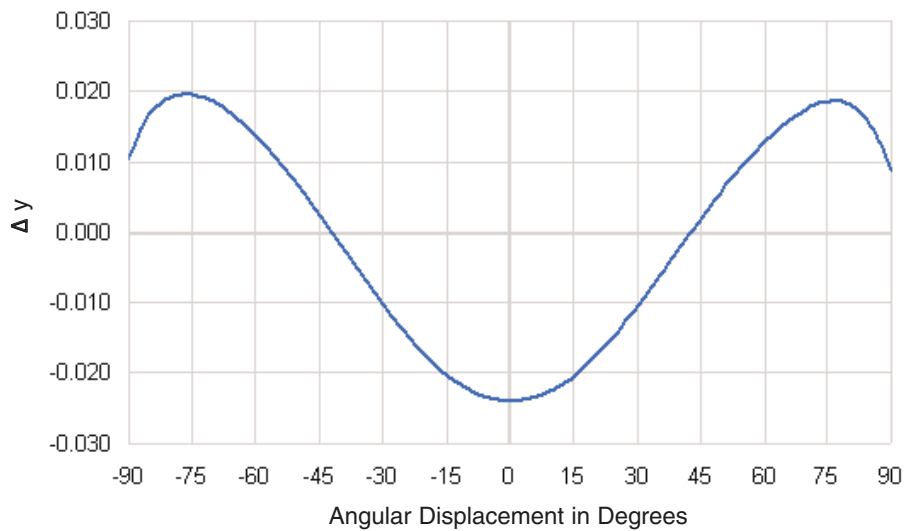

Figure 12b. Y coordinate vs. angle for warm-white LUXEON Rebel.

# Emitter Pocket Tape Packaging

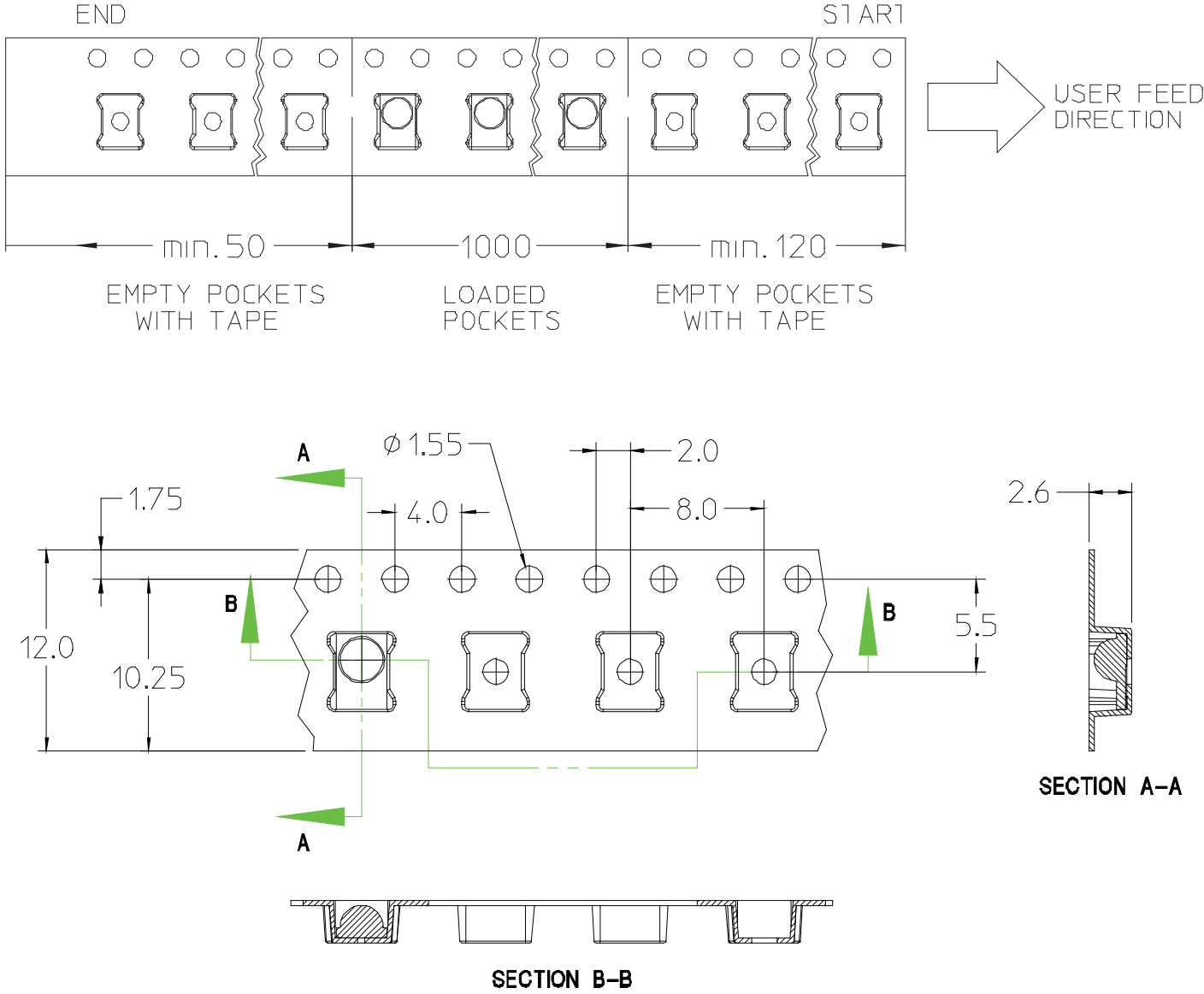

Figure 13. Emitter pocket tape packaging

# Emitter Reel Packaging

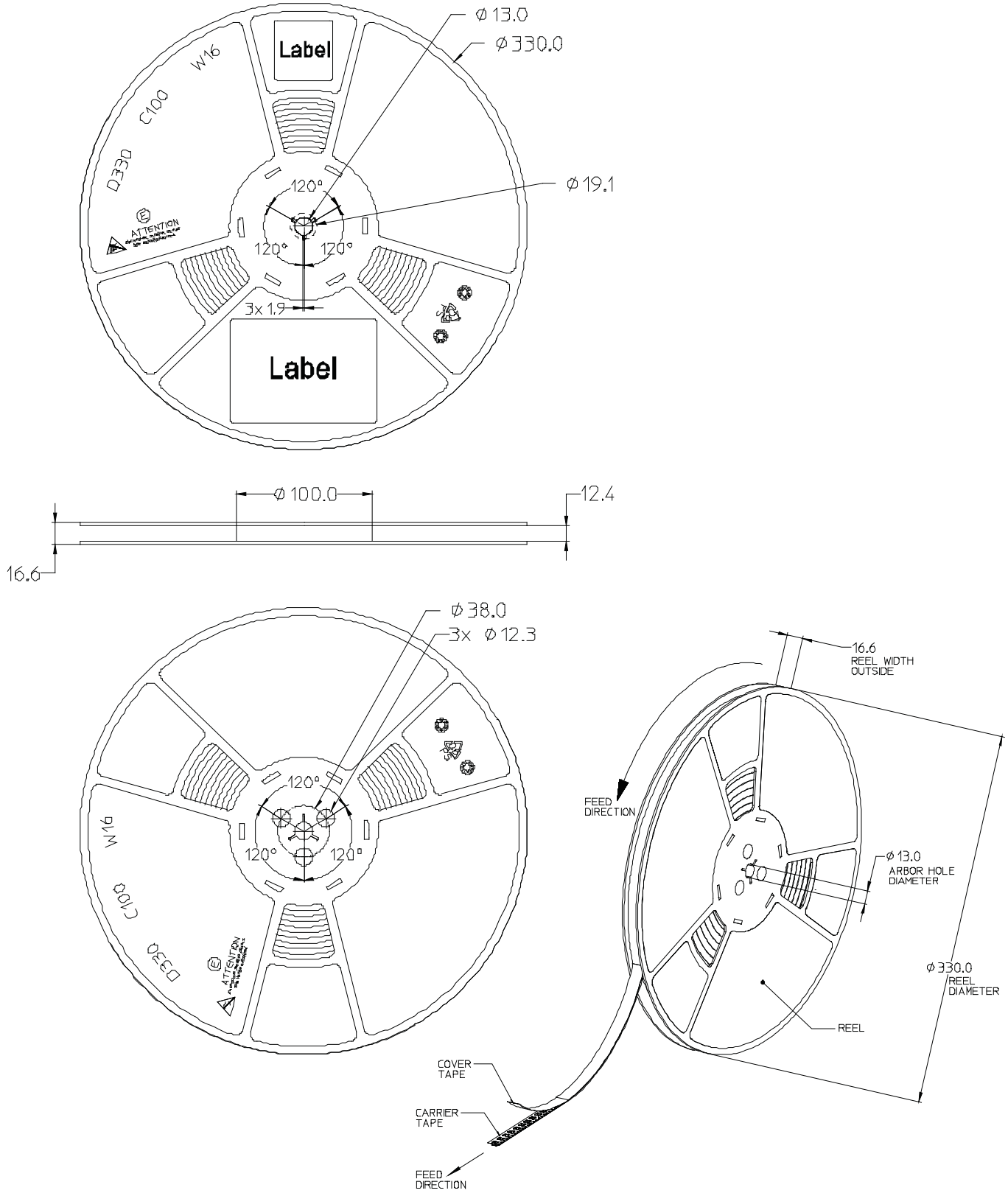

Figure 14. Emitter reel packaging

# Product Binning and Labeling

## **Purpose of Product Binning**

In the manufacturing of semiconductor products, there is a variation of performance around the average values given in the technical data sheets. For this reason, Philips Lumileds bins the LED components for luminous flux, color and forward voltage ( $V_f$ ).

## **Decoding Product Bin Labeling**

LUXEON Rebel Emitters are labeled using a three or four digit alphanumeric code (CAT code) depicting the bin values for emitters packaged on a single reel. All emitters packaged within a reel are of the same 3-variable bin combination. Using these codes, it is possible to determine optimum mixing and matching of products for consistency in a given application.

Reels of Cool-White, Neutral-White and Warm-White Emitters are labeled with a four digit alphanumeric CAT code following the format below.

ABCD

A = Flux bin (J, K, L, M etc.)

B and C = Color bin (W0, U0, V0 etc.)

D =  $V_f$  bin (D, E, F, G etc.)

# Luminous Flux Bins

Table 8 lists the standard photometric luminous flux bins for LUXEON Rebel emitters (tested and binned at 350 mA).

Although several bins are outlined, product availability in a particular bin varies by production run and by product performance. Not all bins are available in all colors.

Table 8.

Flux Bins

Bin Code	Minimum Photometric Flux (lm)	Maximum Photometric Flux (lm)
G	40	50
H	50	60
J	60	70
K	70	80
L	80	90
M	90	100
N	100	120
P	120	140
Q	140	160
R	160	180
S	180	200
T	200	220
U	220	240
V	240	260
W	260	280
X	280	300



# Cool-White Bin Structure

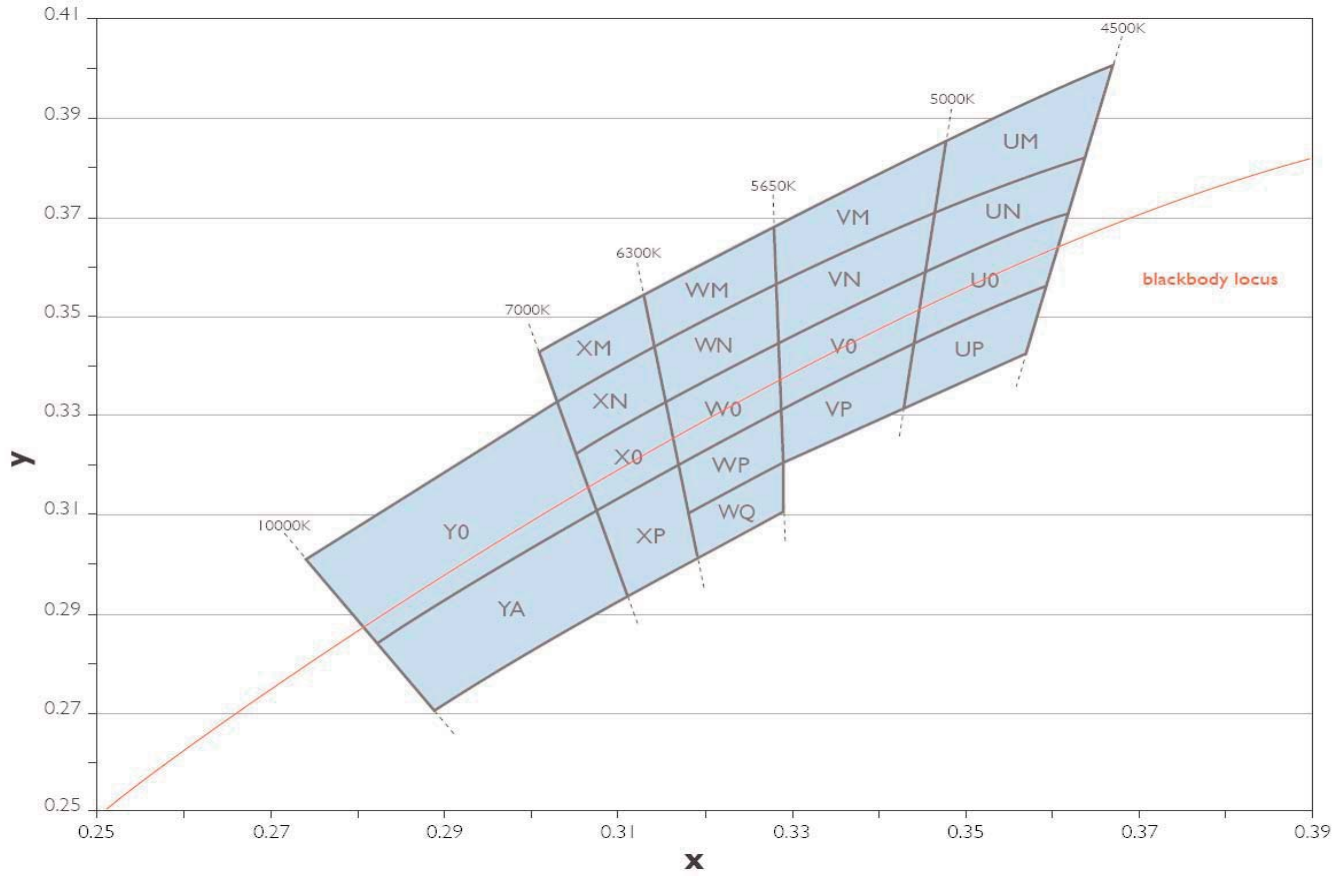

Figure 15. Cool-White bin structure.

Cool-White LUXEON Rebel Emitters are tested and binned by x,y coordinates. 19 Color Bins, CCT Range 10,000K to 4,500K.

**Table 9.**

Cool-White Bin Coordinates							
Bin Code	X	Y	Typical CCT (K)	Bin Code	X	Y	Typical CCT (K)
Y0	0.274238	0.300667	8000	WQ	0.318606	0.310201	6000
	0.303051	0.332708			0.329393	0.320211	
	0.307553	0.310778			0.329544	0.310495	
	0.282968	0.283772			0.319597	0.301303	
YA	0.282968	0.283772	8000	VM	0.328636	0.368952	5300
	0.307553	0.310778			0.348147	0.385629	
	0.311163	0.293192			0.346904	0.371742	
	0.289922	0.270316			0.328823	0.356917	
XM	0.301093	0.342244	6700	VN	0.328823	0.356917	5300
	0.313617	0.354992			0.346904	0.371742	
	0.314792	0.344438			0.345781	0.359190	
	0.303051	0.332708			0.329006	0.345092	
XN	0.303051	0.332708	6700	V0	0.329006	0.345092	5300
	0.314792	0.344438			0.345781	0.359190	
	0.316042	0.333222			0.344443	0.344232	
	0.305170	0.322386			0.329220	0.331331	
X0	0.305170	0.322386	6700	VP	0.329220	0.331331	5300
	0.316042	0.333222			0.344443	0.344232	
	0.317466	0.320438			0.343352	0.332034	
	0.307553	0.310778			0.329393	0.320211	
XP	0.307553	0.310778	6700	UM	0.348147	0.385629	4750
	0.317466	0.320438			0.367294	0.400290	
	0.319597	0.301303			0.364212	0.382878	
	0.311163	0.293192			0.346904	0.371742	
WM	0.313617	0.354992	6000	UN	0.346904	0.371742	4750
	0.328636	0.368952			0.364212	0.382878	
	0.328823	0.356917			0.362219	0.371616	
	0.314792	0.344438			0.345781	0.359190	
WN	0.314792	0.344438	6000	U0	0.345781	0.359190	4750
	0.328823	0.356917			0.362219	0.371616	
	0.329006	0.345092			0.359401	0.355699	
	0.316042	0.333222			0.344443	0.344232	
W0	0.316042	0.333222	6000	UP	0.344443	0.344232	4750
	0.329006	0.345092			0.359401	0.355699	
	0.329220	0.331331			0.357079	0.342581	
	0.317466	0.320438			0.343352	0.332034	
WP	0.317466	0.320438	6000				
	0.329220	0.331331					
	0.329393	0.320211					
	0.318606	0.310201					

Note for Table 9:

- I. Philips Lumileds maintains a tester tolerance of  $\pm 0.005$  on x,y color coordinates.

# Neutral-White Bin Structure

Neutral-White LUXEON Rebel Emitters are tested and binned by x,y coordinates. 12 Color Bins, CCT Range 4,500K to 3,500K.

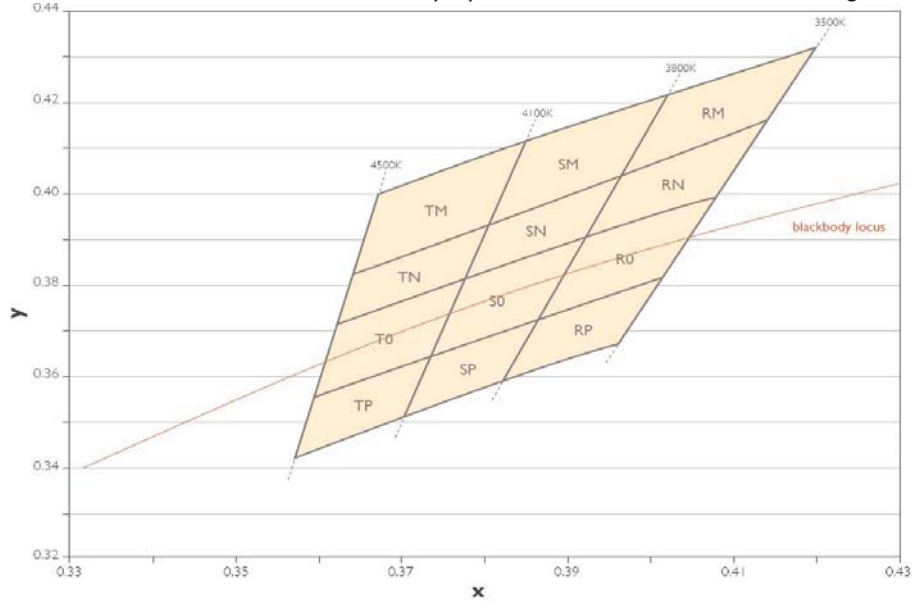

Figure 16. Neutral-White bin structure.

Table 10.

Neutral-White Bin Coordinates

Bin Code	X	Y	Typical CCT (K)	Bin Code	X	Y	Typical CCT (K)
TM	0.367294	0.400290	4300	SO	0.378264	0.382458	3950
	0.385953	0.412995			0.392368	0.390932	
	0.381106	0.393747			0.387071	0.373899	
	0.364212	0.382878			0.374075	0.365822	
TN	0.364212	0.382878	4300	SP	0.374075	0.365822	3950
	0.381106	0.393747			0.387071	0.373899	
	0.378264	0.382458			0.382598	0.359515	
TO	0.362219	0.371616	4300	RM	0.370582	0.351953	3650
	0.378264	0.382458			0.402270	0.422776	
	0.374075	0.365822			0.420940	0.432618	
TP	0.359401	0.355699	4300	RN	0.414776	0.416097	3650
	0.374075	0.365822			0.396279	0.403508	
	0.370582	0.351953			0.396279	0.403508	
SM	0.357079	0.342581	3950	RO	0.414776	0.416097	3650
	0.385953	0.412995			0.408593	0.399525	
	0.402270	0.422776			0.392368	0.390932	
SN	0.396279	0.403508	3950	RP	0.402113	0.382156	3650
	0.392368	0.390932			0.387071	0.373899	
	0.378264	0.382458			0.387071	0.373899	
					0.402113	0.382156	
					0.396564	0.367284	
					0.382598	0.359515	

Note for Table 10:

- I. Philips Lumileds maintains a tester tolerance of  $\pm 0.005$  on x,y color coordinates.

# Warm-White Bin Structure

Warm-White LUXEON Rebel Emitters are tested and binned by x,y coordinates. 15 Color Bins, CCT Range 3,500K to 2,540K.

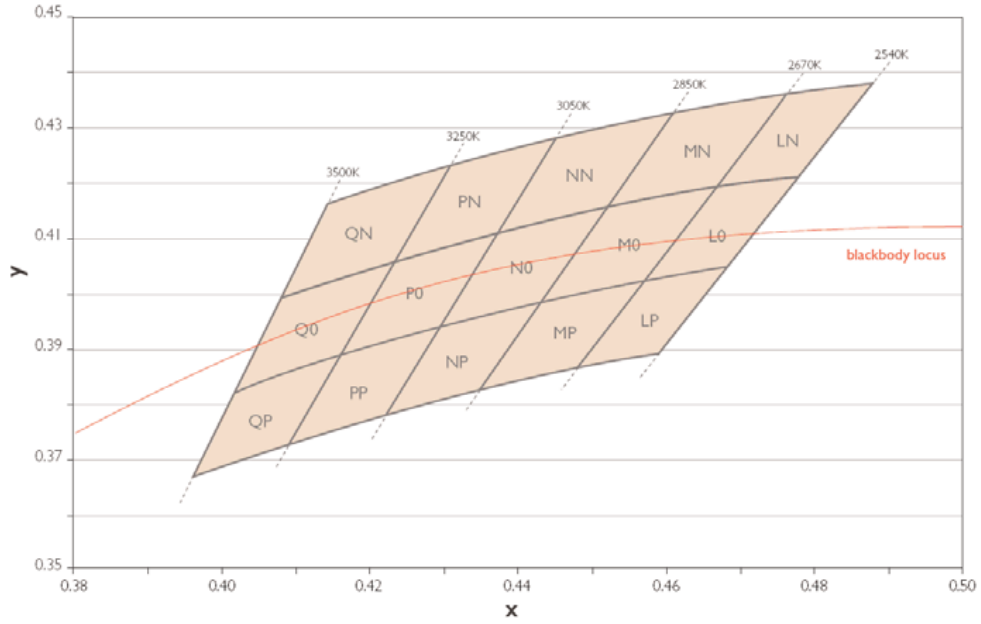

Figure 17. Warm-White bin structure.

**Table II.**

**Warm-White Bin Coordinates**

Bin Code	X	Y	Typical CCT (K)	Bin Code	X	Y	Typical CCT (K)
QN	0.414776	0.416097	3375	NP	0.429373	0.394281	2950
	0.431186	0.423386			0.443600	0.399111	
	0.423956	0.406472			0.435591	0.383714	
	0.408593	0.399525			0.422124	0.378952	
QO	0.408593	0.399525	3375	MN	0.461404	0.433334	2760
	0.423956	0.406472			0.476733	0.436634	
	0.416487	0.389001			0.467132	0.419632	
	0.402113	0.382156			0.452512	0.416241	
QP	0.402113	0.382156	3375	MO	0.452512	0.416241	2760
	0.416487	0.389001			0.467132	0.419632	
	0.409996	0.373814			0.457663	0.402866	
	0.396564	0.367284			0.443600	0.399111	
PN	0.431186	0.423386	3150	MP	0.443600	0.399111	2760
	0.445639	0.428680			0.457663	0.402866	
	0.437578	0.411632			0.448994	0.387515	
	0.423956	0.406472			0.435591	0.383714	
PO	0.423956	0.406472	3150	LN	0.476733	0.436634	2605
	0.437578	0.411632			0.488403	0.438170	
	0.429373	0.394281			0.478372	0.421400	
	0.416487	0.389001			0.467132	0.419632	
PP	0.416487	0.389001	3150	LO	0.467132	0.419632	2605
	0.429373	0.394281			0.478372	0.421400	
	0.422124	0.378952			0.468646	0.405140	
	0.409996	0.373814			0.457663	0.402866	
NN	0.445639	0.428680	2950	LP	0.468646	0.405140	2605
	0.461404	0.433334			0.457663	0.402866	
	0.452512	0.416241			0.448994	0.387515	
	0.437578	0.411632			0.459563	0.389955	
NO	0.437578	0.411632	2950				
	0.452512	0.416241					
	0.443600	0.399111					
	0.429373	0.394281					

Note for Table II:

- I. Philips Lumileds maintains a tester tolerance of  $\pm 0.005$  on x,y color coordinates.

# Forward Voltage Bins

Table 13 lists minimum and maximum  $V_f$  bin values per emitter. Although several bins are outlined, product availability in a particular bin varies by production run and by product performance.

**Table 12.**

$V_f$ Bins		
Bin Code	Minimum Forward Voltage (V)	Maximum Forward Voltage (V)
B	2.55	2.79
C	2.79	3.03
D	3.03	3.27
E	3.27	3.51
F	3.51	3.75
G	3.75	3.99

# Company Information

Philips Lumileds is the world's leading provider of power LEDs for everyday lighting applications. The company's records for light output, efficiency and thermal management are direct results of the ongoing commitment to advancing solid-state lighting technology and enabling lighting solutions that are more environmentally friendly, help reduce CO<sub>2</sub> emissions and reduce the need for power plant expansion. Philips Lumileds LUXEON® LEDs are enabling never before possible applications in outdoor lighting, shop lighting and home lighting.

Philips Lumileds is a fully integrated supplier, producing core LED material in all three base colors, (Red, Green, Blue) and white. Philips Lumileds has R&D centers in San Jose, California and in the Netherlands, and production capabilities in San Jose, Singapore and Penang Malaysia. Founded in 1999, Philips Lumileds is the high flux LED technology leader and is dedicated to bridging the gap between solid-state technology and the lighting world. More information about the company's LUXEON LED products and solid-state lighting technologies can be found at [www.philipslumileds.com](http://www.philipslumileds.com).

[www.philipslumileds.com](http://www.philipslumileds.com)  
[www.futurelightingsolutions.com](http://www.futurelightingsolutions.com)

For technical assistance or the location of your nearest sales office contact any of the following:

North America:  
1 888 589 3662  
[americas@futurelightingsolutions.com](mailto:americas@futurelightingsolutions.com)

Europe:  
00 800 443 88 873  
[europa@futurelightingsolutions.com](mailto:europa@futurelightingsolutions.com)

Asia Pacific:  
800 5864 5337  
[asia@futurelightingsolutions.com](mailto:asia@futurelightingsolutions.com)

Japan:  
800 5864 5337  
[japan@futurelightingsolutions.com](mailto:japan@futurelightingsolutions.com)

©2009 Philips Lumileds Lighting Company. All rights reserved.  
Product specifications are subject to change without notice.  
LUXEON is a registered trademark of the Philips Lumileds Lighting Company in the United States and other countries.

**PHILIPS**  
**LUMILEDS**