

MBRS320T3, MBRS330T3, MBRS340T3, MBRS360T3

Preferred Devices

Surface Mount Schottky Power Rectifier

...employing the Schottky Barrier principle in a large area metal-to-silicon power diode. State-of-the-art geometry features epitaxial construction with oxide passivation and metal overlay contact. Ideally suited for low voltage, high frequency rectification, or as free wheeling and polarity protection diodes, in surface mount applications where compact size and weight are critical to the system.

- Small Compact Surface Mountable Package with J-Bend Leads
- Rectangular Package for Automated Handling
- Highly Stable Oxide Passivated Junction
- Very Low Forward Voltage Drop
(0.5 Volts Max @ 3.0 A, $T_J = 25^\circ\text{C}$)
- Excellent Ability to Withstand Reverse Avalanche Energy Transients
- Guardring for Stress Protection

Mechanical Characteristics:

- Case: Epoxy, Molded
- Weight: 217 mg (approximately)
- Finish: All External Surfaces Corrosion Resistant and Terminal Leads are Readily Solderable
- Lead and Mounting Surface Temperature for Soldering Purposes: 260°C Max. for 10 Seconds
- Shipped in 16 mm Tape and Reel, 2500 units per reel
- Polarity: Notch in Plastic Body Indicates Cathode Lead
- Marking: B32, B33, B34, B36

MAXIMUM RATINGS

Please See the Table on the Following Page



ON Semiconductor™

<http://onsemi.com>

**SCHOTTKY BARRIER
RECTIFIERS
3.0 AMPERES
20, 30, 40, 60 VOLTS**



SMC
CASE 403
PLASTIC

MARKING DIAGRAM

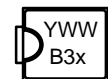

B3x = Device Code
x = 2, 3, 4 or 6
Y = Year
W = Work Week

ORDERING INFORMATION

Device	Package	Shipping
MBRS320T3	SMC	2500/Tape & Reel
MBRS330T3	SMC	2500/Tape & Reel
MBRS340T3	SMC	2500/Tape & Reel
MBRS360T3	SMC	2500/Tape & Reel

Preferred devices are recommended choices for future use and best overall value.

MBRS320T3, MBRS330T3, MBRS340T3, MBRS360T3

MAXIMUM RATINGS

Rating	Symbol	MBRS320T3	MBRS330T3	MBRS340T3	MBRS360T3	Unit
Peak Repetitive Reverse Voltage Working Peak Reverse Voltage DC Blocking Voltage	V_{RRM} V_{RWM} V_R	20	30	40	60	Volts
Average Rectified Forward Current	$I_{F(AV)}$	3.0 @ $T_L = 100^\circ\text{C}$ 4.0 @ $T_L = 90^\circ\text{C}$				Amps
Nonrepetitive Peak Surge Current (Surge applied at rated load conditions halfwave, single phase, 60 Hz)	I_{FSM}	80	80	80	80	Amps
Operating Junction Temperature	T_J	- 65 to +125	- 65 to +125	- 65 to +125		$^\circ\text{C}$

THERMAL CHARACTERISTICS

Thermal Resistance — Junction to Lead	$R_{\theta JL}$	11	11	11	11	$^\circ\text{C/W}$
---------------------------------------	-----------------	----	----	----	----	--------------------

ELECTRICAL CHARACTERISTICS

Maximum Instantaneous Forward Voltage (Note 1.) ($i_F = 3.0\text{ A}$, $T_J = 25^\circ\text{C}$)	V_F	0.50	0.50	0.525	0.740	Volts
Maximum Instantaneous Reverse Current (Note 1.) (Rated dc Voltage, $T_J = 25^\circ\text{C}$) (Rated dc Voltage, $T_J = 100^\circ\text{C}$)	i_R	2.0 20	2.0 20	2.0 20	0.5 20	mA

1. Pulse Test: Pulse Width = 300 μs , Duty Cycle $\leq 2.0\%$.

MBRS320T3, MBRS330T3, MBRS340T3, MBRS360T3

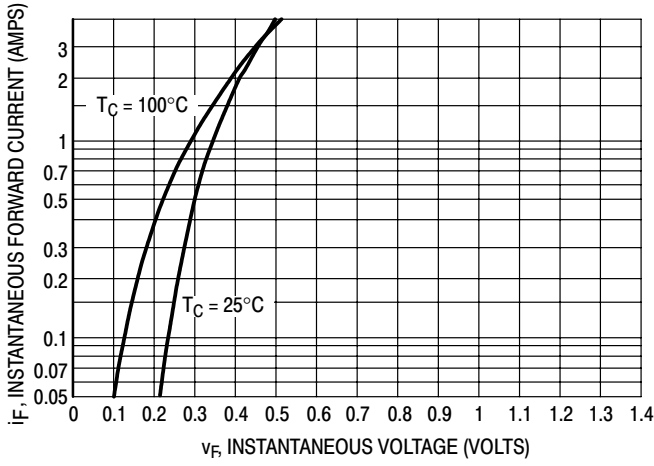

Figure 1. Typical Forward Voltage

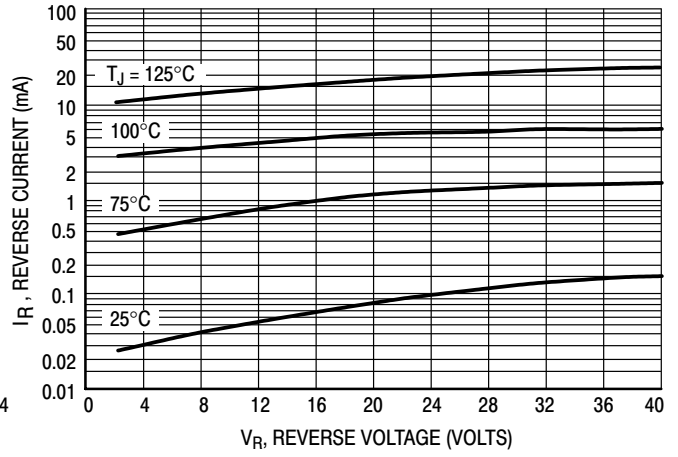

Figure 2. Typical Reverse Current

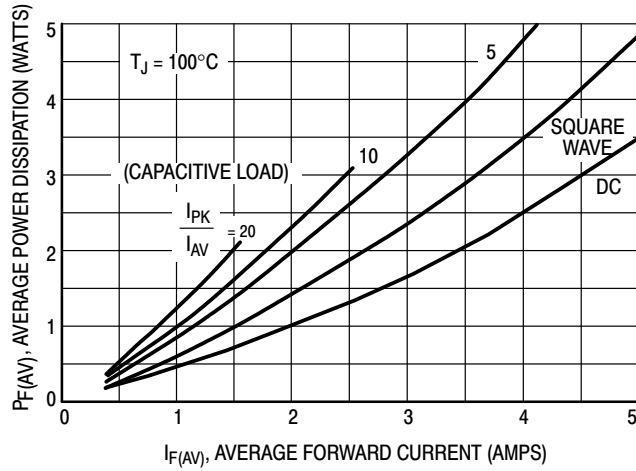

Figure 3. Power Dissipation

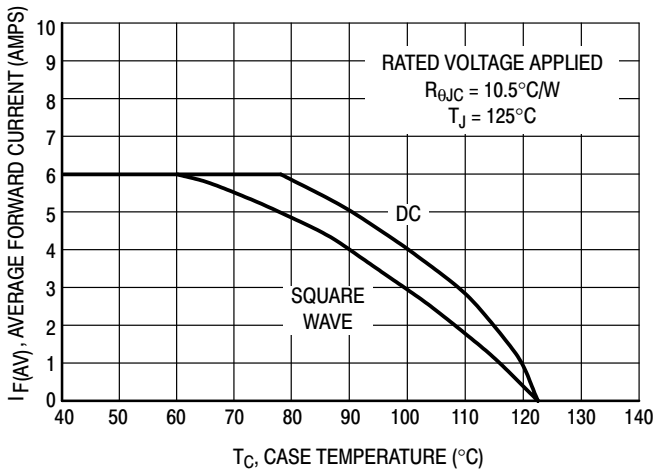

Figure 4. Current Derating (Case)

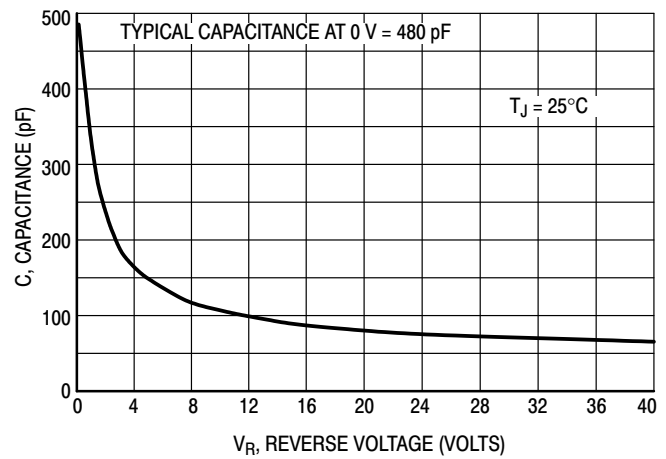
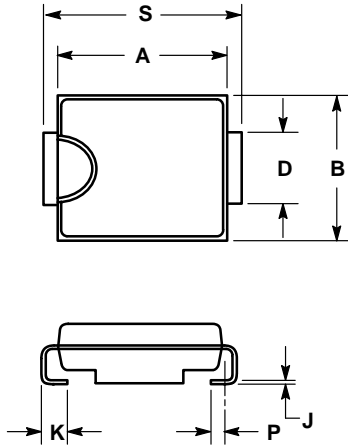

Figure 5. Typical Capacitance

MBRS320T3, MBRS330T3, MBRS340T3, MBRS360T3

PACKAGE DIMENSIONS

SMC
PLASTIC PACKAGE
CASE 403-03
ISSUE B



- NOTES:
1. DIMENSIONING AND TOLERANCING PER ANSI Y14.5M, 1982.
 2. CONTROLLING DIMENSION: INCH.
 3. D DIMENSION SHALL BE MEASURED WITHIN DIMENSION P.

DIM	INCHES		MILLIMETERS	
	MIN	MAX	MIN	MAX
A	0.260	0.280	6.60	7.11
B	0.220	0.240	5.59	6.10
C	0.075	0.095	1.90	2.41
D	0.115	0.121	2.92	3.07
H	0.0020	0.0060	0.051	0.152
J	0.006	0.012	0.15	0.30
K	0.030	0.050	0.76	1.27
P	0.020 REF		0.51 REF	
S	0.305	0.320	7.75	8.13

ON Semiconductor and  are trademarks of Semiconductor Components Industries, LLC (SCILLC). SCILLC reserves the right to make changes without further notice to any products herein. SCILLC makes no warranty, representation or guarantee regarding the suitability of its products for any particular purpose, nor does SCILLC assume any liability arising out of the application or use of any product or circuit, and specifically disclaims any and all liability, including without limitation special, consequential or incidental damages. "Typical" parameters which may be provided in SCILLC data sheets and/or specifications can and do vary in different applications and actual performance may vary over time. All operating parameters, including "Typicals" must be validated for each customer application by customer's technical experts. SCILLC does not convey any license under its patent rights nor the rights of others. SCILLC products are not designed, intended, or authorized for use as components in systems intended for surgical implant into the body, or other applications intended to support or sustain life, or for any other application in which the failure of the SCILLC product could create a situation where personal injury or death may occur. Should Buyer purchase or use SCILLC products for any such unintended or unauthorized application, Buyer shall indemnify and hold SCILLC and its officers, employees, subsidiaries, affiliates, and distributors harmless against all claims, costs, damages, and expenses, and reasonable attorney fees arising out of, directly or indirectly, any claim of personal injury or death associated with such unintended or unauthorized use, even if such claim alleges that SCILLC was negligent regarding the design or manufacture of the part. SCILLC is an Equal Opportunity/Affirmative Action Employer.

PUBLICATION ORDERING INFORMATION

NORTH AMERICA Literature Fulfillment:

Literature Distribution Center for ON Semiconductor
P.O. Box 5163, Denver, Colorado 80217 USA
Phone: 303-675-2175 or 800-344-3860 Toll Free USA/Canada
Fax: 303-675-2176 or 800-344-3867 Toll Free USA/Canada
Email: ONlit@hibbertco.com
Fax Response Line: 303-675-2167 or 800-344-3810 Toll Free USA/Canada

N. American Technical Support: 800-282-9855 Toll Free USA/Canada

EUROPE: LDC for ON Semiconductor – European Support

German Phone: (+1) 303-308-7140 (Mon-Fri 2:30pm to 7:00pm CET)
Email: ONlit-german@hibbertco.com
French Phone: (+1) 303-308-7141 (Mon-Fri 2:00pm to 7:00pm CET)
Email: ONlit-french@hibbertco.com
English Phone: (+1) 303-308-7142 (Mon-Fri 12:00pm to 5:00pm GMT)
Email: ONlit@hibbertco.com

EUROPEAN TOLL-FREE ACCESS*: 00-800-4422-3781

*Available from Germany, France, Italy, UK, Ireland

CENTRAL/SOUTH AMERICA:

Spanish Phone: 303-308-7143 (Mon-Fri 8:00am to 5:00pm MST)
Email: ONlit-spanish@hibbertco.com
Toll-Free from Mexico: Dial 01-800-288-2872 for Access –
then Dial 866-297-9322

ASIA/PACIFIC: LDC for ON Semiconductor – Asia Support

Phone: 303-675-2121 (Tue-Fri 9:00am to 1:00pm, Hong Kong Time)
Toll Free from Hong Kong & Singapore:
001-800-4422-3781
Email: ONlit-asia@hibbertco.com

JAPAN: ON Semiconductor, Japan Customer Focus Center
4-32-1 Nishi-Gotanda, Shinagawa-ku, Tokyo, Japan 141-0031
Phone: 81-3-5740-2700
Email: r14525@onsemi.com

ON Semiconductor Website: <http://onsemi.com>

For additional information, please contact your local Sales Representative.