

## NDP603AL / NDB603AL

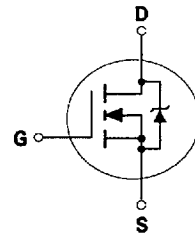
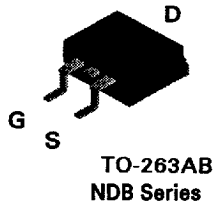
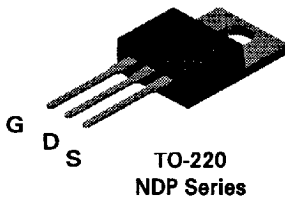
### N-Channel Logic Level Enhancement Mode Field Effect Transistor

#### General Description

These N-Channel logic level enhancement mode power field effect transistors are produced using National's proprietary, high cell density, DMOS technology. This very high density process is especially tailored to minimize on-state resistance. These devices are particularly suited for low voltage applications such as DC/DC converters and high efficiency switching circuits where fast switching, low in-line power loss, and resistance to transients are needed.

#### Features

- 25A, 30V.  $R_{DS(ON)} = 0.022\Omega @ V_{GS}=10V$ .
- Critical DC electrical parameters specified at elevated temperature.
- Rugged internal source-drain diode can eliminate the need for an external Zener diode transient suppressor.
- High density cell design for extremely low  $R_{DS(ON)}$ .
- 175°C maximum junction temperature rating.



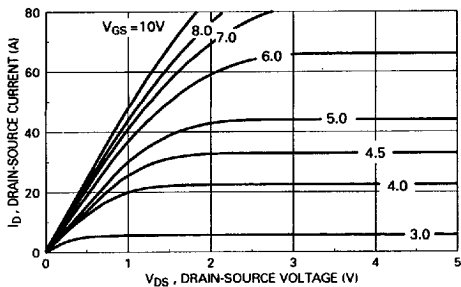
#### Absolute Maximum Ratings $T_C = 25^\circ\text{C}$ unless otherwise noted

Symbol	Parameter	NDP603AL	NDB603AL	Units
$V_{DS}$	Drain-Source Voltage	30		V
$V_{GS}$	Gate-Source Voltage - Continuous	$\pm 20$		V
$I_D$	Drain Current - Continuous	25 (Note 1)		A
	- Pulsed	100		
$P_D$	Total Power Dissipation @ $T_C = 25^\circ\text{C}$	50		W
	Derate above $25^\circ\text{C}$	0.4		
$T_J, T_{STG}$	Operating and Storage Temperature Range	-65 to 175		°C
$T_L$	Maximum lead temperature for soldering purposes, 1/8" from case for 5 seconds	275		°C
<b>THERMAL CHARACTERISTICS</b>				
$R_{\theta JC}$	Thermal Resistance, Junction-to-Case	2.5		°C/W
$R_{\theta JA}$	Thermal Resistance, Junction-to-Ambient	62.5		°C/W

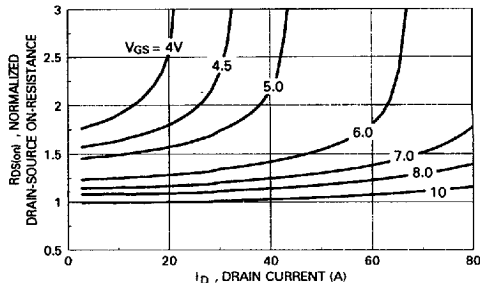
**Electrical Characteristics** ( $T_C = 25^\circ\text{C}$  unless otherwise noted)

Symbol	Parameter	Conditions	Min	Typ	Max	Units	
<b>DRAIN-SOURCE AVALANCHE RATINGS</b> (Note 2)							
$W_{DSS}$	Single Pulse Drain-Source Avalanche Energy	$V_{DD} = 15\text{ V}, I_b = 25\text{ A}$			100	mJ	
$I_{AR}$	Maximum Drain-Source Avalanche Current				25	A	
<b>OFF CHARACTERISTICS</b>							
$BV_{DSS}$	Drain-Source Breakdown Voltage	$V_{GS} = 0\text{ V}, I_b = 250\ \mu\text{A}$	30			V	
$I_{DSS}$	Zero Gate Voltage Drain Current	$V_{DS} = 24\text{ V}, V_{GS} = 0\text{ V}$			10	$\mu\text{A}$	
$I_{GSSF}$	Gate - Body Leakage, Forward	$V_{GS} = 20\text{ V}, V_{DS} = 0\text{ V}$			100	nA	
$I_{GSSR}$	Gate - Body Leakage, Reverse	$V_{GS} = -20\text{ V}, V_{DS} = 0\text{ V}$			-100	nA	
<b>ON CHARACTERISTICS</b> (Note 2)							
$V_{GS(th)}$	Gate Threshold Voltage	$V_{DS} = V_{GS}, I_b = 250\ \mu\text{A}$		1.1	1.5	3	V
			$T_J = 125^\circ\text{C}$	0.7	1.1	2.2	
		$V_{DS} = V_{GS}, I_b = 10\text{ mA}$		1.4	1.85	3	
			$T_J = 125^\circ\text{C}$	1	1.5	2.2	
$R_{DS(on)}$	Static Drain-Source On-Resistance	$V_{GS} = 10\text{ V}, I_b = 25\text{ A}$			0.019	0.022	$\Omega$
			$T_J = 125^\circ\text{C}$			0.028	
		$V_{GS} = 4.5\text{ V}, I_b = 10\text{ A}$			0.031	0.04	
$I_{D(on)}$	On-State Drain Current	$V_{GS} = 10\text{ V}, V_{DS} = 10\text{ V}$	60			A	
		$V_{GS} = 4.5\text{ V}, V_{DS} = 10\text{ V}$	15				
$g_{FS}$	Forward Transconductance	$V_{DS} = 10\text{ V}, I_b = 25\text{ A}$		18		S	
<b>DYNAMIC CHARACTERISTICS</b>							
$C_{iss}$	Input Capacitance	$V_{DS} = 15\text{ V}, V_{GS} = 0\text{ V},$ $f = 1.0\text{ MHz}$		1100		pF	
$C_{oss}$	Output Capacitance			540		pF	
$C_{rss}$	Reverse Transfer Capacitance			175		pF	
<b>SWITCHING CHARACTERISTICS</b> (Note 2)							
$t_{D(on)}$	Turn - On Delay Time	$V_{DD} = 15\text{ V}, I_b = 25\text{ A},$ $V_{GS} = 10\text{ V}, R_{GEN} = 24\ \Omega$		15	30	ns	
$t_r$	Turn - On Rise Time			70	110	ns	
$t_{D(off)}$	Turn - Off Delay Time			90	150	ns	
$t_f$	Turn - Off Fall Time			80	130	ns	
$Q_g$	Total Gate Charge	$V_{DS} = 10\text{ V},$ $I_b = 25\text{ A}, V_{GS} = 10\text{ V}$		28	40	nC	
$Q_{gs}$	Gate-Source Charge			5	7	nC	
$Q_{gd}$	Gate-Drain Charge			7	10	nC	
<b>DRAIN-SOURCE DIODE CHARACTERISTICS AND MAXIMUM RATINGS</b>							
$I_S$	Maximum Continuous Drain-Source Diode Forward Current				25	A	
$V_{SD}$	Drain-Source Diode Forward Voltage	$V_{GS} = 0\text{ V}, I_S = 25\text{ A}$ (Note 2)			1.3	V	
Note:							
1. Maximum DC current limited by the package.							
2. Pulse Test: Pulse Width $\leq 300\ \mu\text{s}$ , Duty Cycle $\leq 2.0\%$ .							

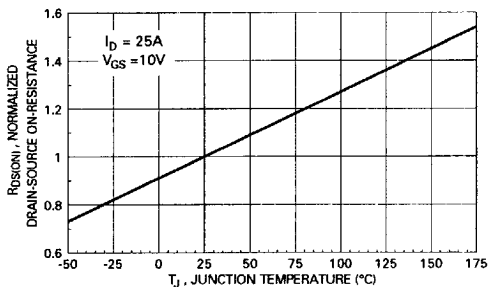
# Typical Electrical Characteristics



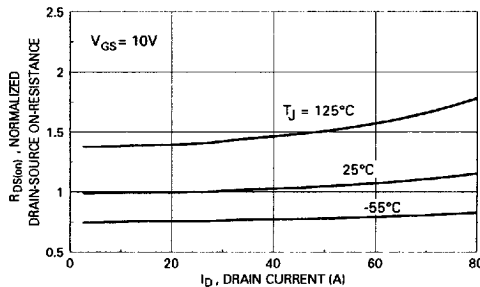
**Figure 1. On-Region Characteristics.**



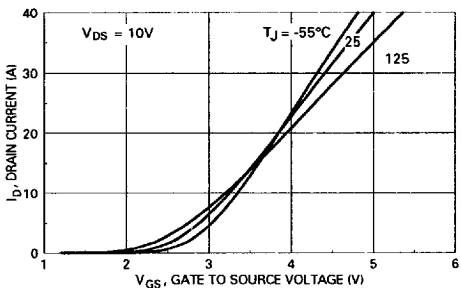
**Figure 2. On-Resistance Variation with Gate Voltage and Drain Current.**



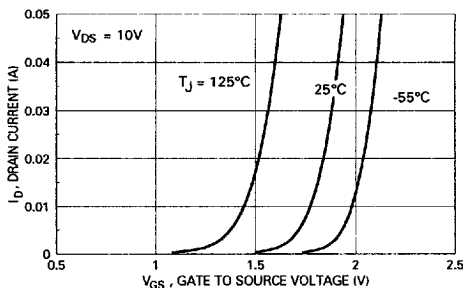
**Figure 3. On-Resistance Variation with Temperature.**



**Figure 4. On-Resistance Variation with Drain Current and Temperature.**

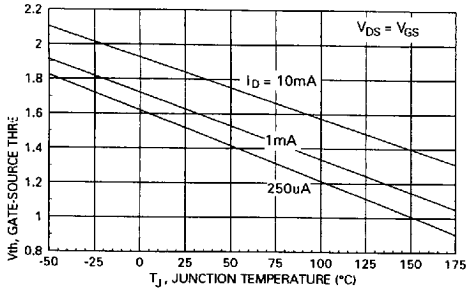


**Figure 5. Drain Current Variation with Gate Voltage and Temperature.**

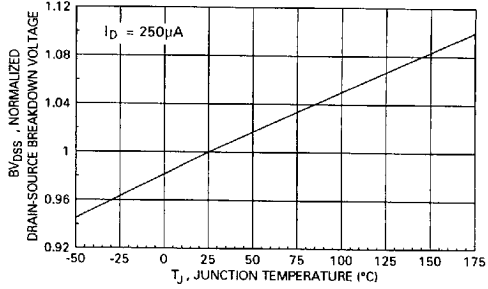


**Figure 6. Sub-threshold Drain Current Variation with Gate Voltage and Temperature.**

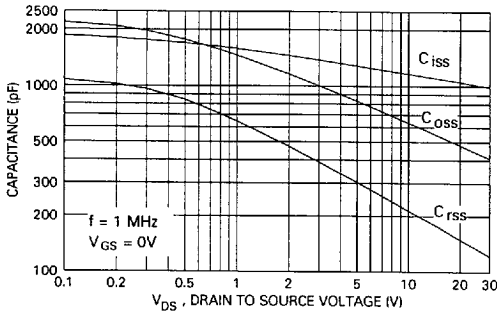
# Typical Electrical Characteristics (continued)



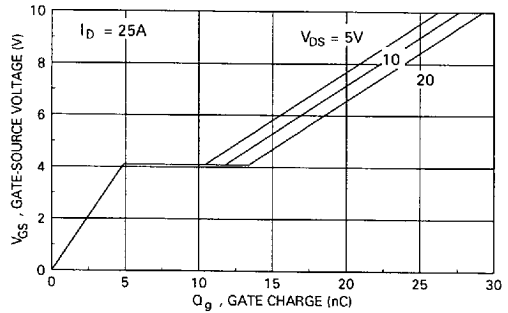
**Figure 7. Gate Threshold Variation with Temperature**



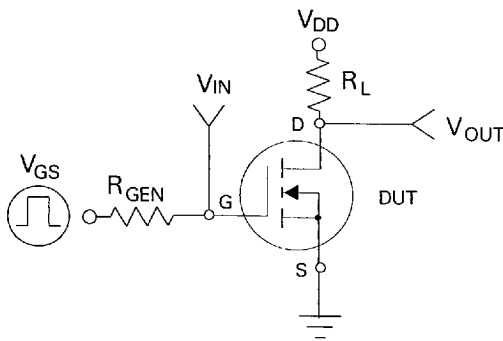
**Figure 8. Breakdown Voltage Variation with Temperature.**



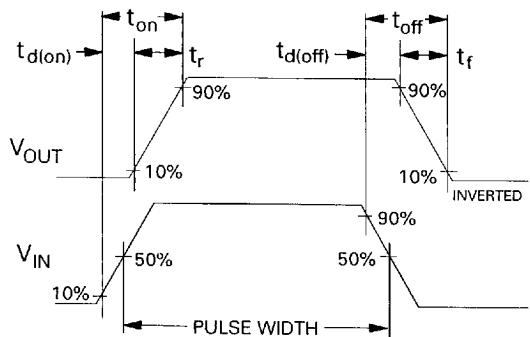
**Figure 9. Capacitance Characteristics.**



**Figure 10. Gate Charge Characteristics.**



**Figure 11. Switching Test Circuit**



**Figure 12. Switching Waveforms**

## Typical Electrical Characteristics (continued)

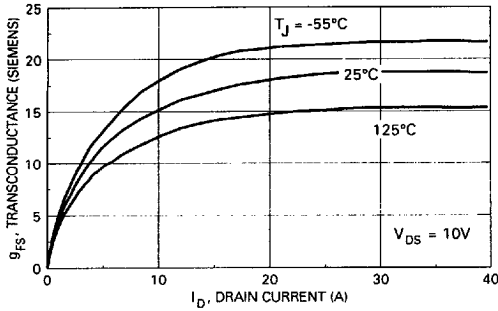


Figure 13. Transconductance Variation with Drain Current and Temperature

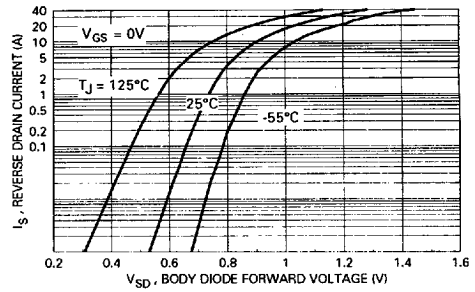


Figure 14. Body Diode Forward Voltage Variation with Current and Temperature

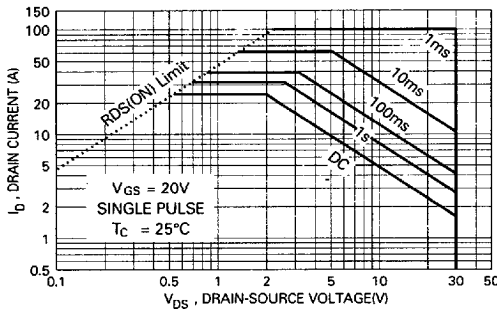


Figure 15. Maximum Safe Operating Area

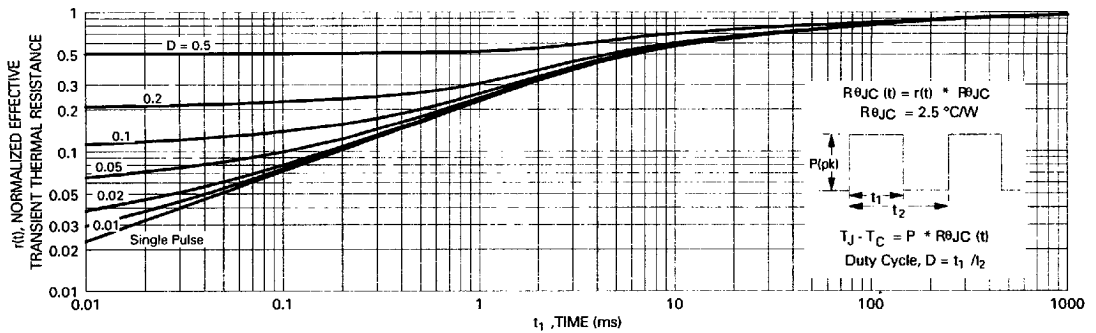


Figure 16. Transient Thermal Response Curve