

DATE OF ISSUE : 2009. 04. 10

SPECIFICATION

MODEL : SLHNNWW511T1

[Rank : (S0), (S0, U0, T0), (F1, G1, H1)]

HIGH POWER LED – SUNNIX5

CUSTOMER : _____

CUSTOMER		
CHECKED	CHECKED	APPROVED
Preliminary		

SAMSUNG LED			
DRAWN	CHECKED(Sales)	CHECKED(Quality)	APPROVED

SAMSUNG LED CO.,LTD.
314, MAETAN3-DONG, YEONGTONG-GU,
SUWON-SI, GYEONGGI-DO, KOREA, 443-743

Contents

1.	Product Outline	3
2.	Absolute Maximum Rating	3
3.	Characteristics	3
4.	Chromaticity Diagram	4
5.	Typical Characteristic Graphs	5
6.	Outline Drawing and Dimension	6
7.	Package Structure	7
8.	Solder Conditions	7
9.	Reliability Test Items and Conditions	8
10.	Taping Dimension	9
11.	Label Structure	10
12.	Lot Number	10
13.	Reel Packing Structure	11
14.	Precaution for Use	13
15.	Hazard Substance Analysis	15
16.	Revision History	18

1. Product Outline

1) Features

- Plastic Molded Lead Frame Type : 7.0 mm(L), 7.0 mm(W), 4.8 mm(T)
- Beam View Angle($\Delta\theta$)* : 55 °
- High Power / Brightness Chip & Long Time Reliability

2) Applications

- Automotive Interior Lamp, Illumination etc.

※ View Angle describes the spatial intensity distribution and is the difference between the angles corresponding to 50% of the maximum intensity.

2. Absolute Maximum Rating

- Operation Forward Current 350 mA
- Reverse Voltage* 5 V
- Thermal Resistance ($R_{th\ j-s}$) \cong 10 °C/W
- Operating Temperature Range (T_{OPR}) -40 °C ~ 85 °C
- Storage Temperature Range (T_{STG}) -40 °C ~ 110 °C
- LED Junction Temperature (T_j) 125 °C

※ Does not operate in the reverse direction.

3. Characteristics

1) Electrical properties ($T_j = 25\text{ °C}$)

Parameter	Symbol	Condition	Rank	Min.	Typ.	Max.	Unit
Reverse Voltage	V_R	$I_R = 10\text{ mA}$	-	0.5	-	2.0	V
Forward Voltage	V_F	$I_F = 350\text{ mA}$	S0	3.0	-	4.0	V

2) Chromaticity Coordinates ($T_j = 25\text{ °C}$)

Rank	CCT(K)	Condition	CCx				CCy			
S0	4000~5000	$I_F = 350\text{ mA}$	0.3428	0.3700	0.3919	0.3484	0.3138	0.3322	0.4190	0.3885
T0	3200~4000		0.3700	0.4041	0.4397	0.3919	0.3322	0.3551	0.4367	0.4190
U0	2600~3200		0.4041	0.4440	0.4880	0.4397	0.3551	0.3700	0.4490	0.4367

3) Luminous Flux ($T_j = 25\text{ °C}$)

Rank		Symbol	Condition	Min.	Typ.	Max.	Unit
G3	F1	Φ_V	$I_F = 350\text{ mA}$	50	-	60	lm
	G1			60	-	70	
	H1			70	-	80	

※ Tolerance : $V_F : \pm 0.1$, $\Phi_V : \pm 10\%$, CCx CCy : ± 0.02

※ Color Rendering Index (R_a) : Typ. 80

4. Chromaticity Diagram

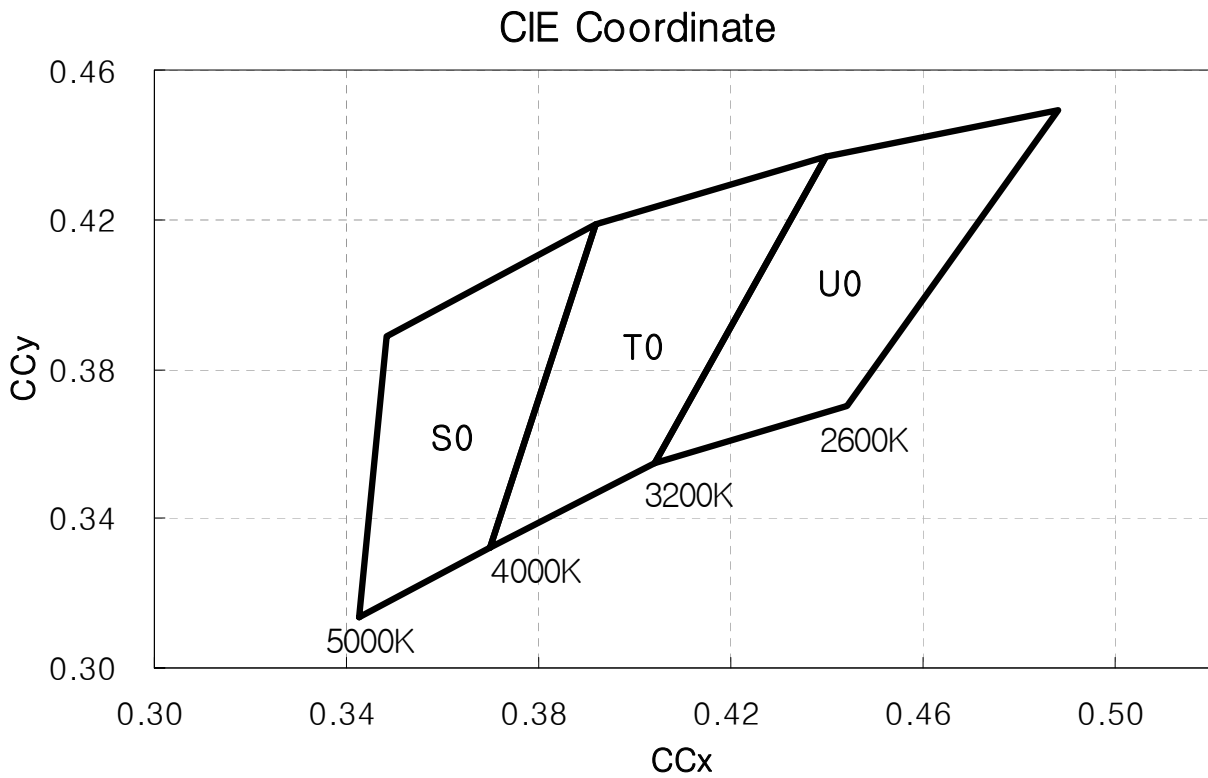

Approved Rank

Symbol	V _F	CIE	Φ _v
Rank	S0	S0, T0, U0	F1, G1, H1

5. Typical Characteristic Graphs

$T_j = 25\text{ }^\circ\text{C}$

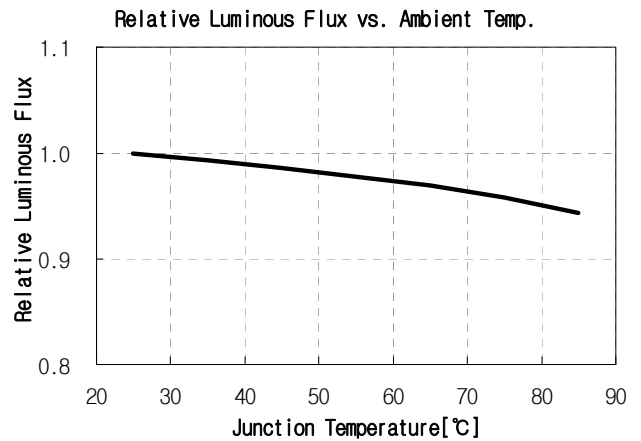
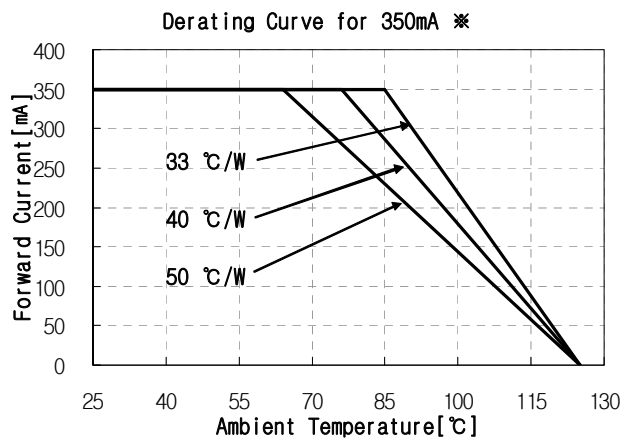
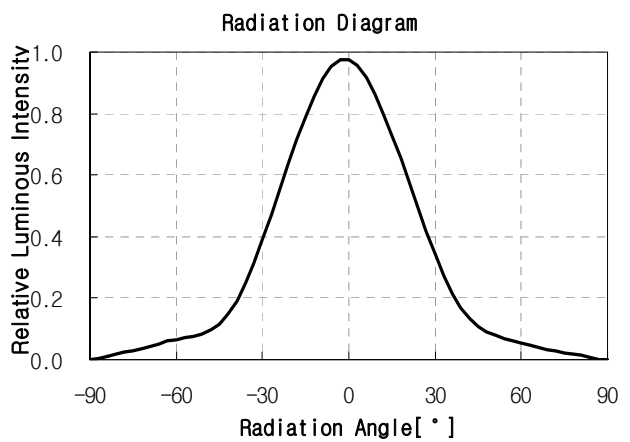
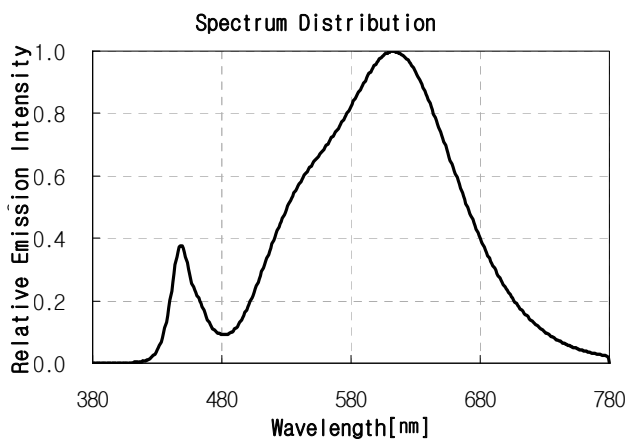
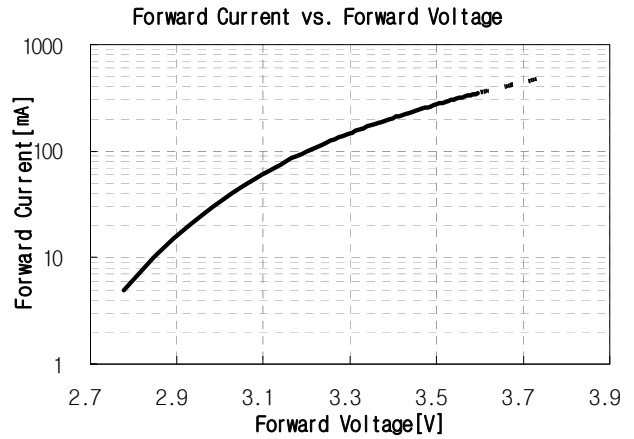
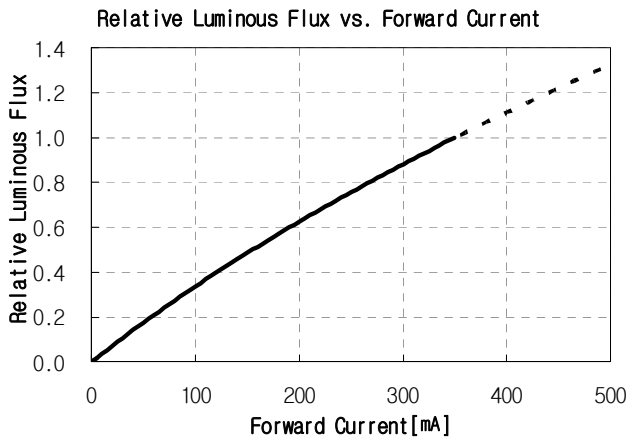

※ Thermal Resistance Test Conditions

- Junction to ambient thermal resistance
- JEDEC Standard JESD 51-2,3

JESD 51-2 : Integrated Circuits Thermal Test Method Environmental Conditions

- Natural Convection (Still Air)

JESD 51-3 : Low Effective Thermal Conductivity Test Board for Leaded Surface Mount Package

6. Outline Drawing and Dimension

Unit : mm
Tolerance : ± 0.1

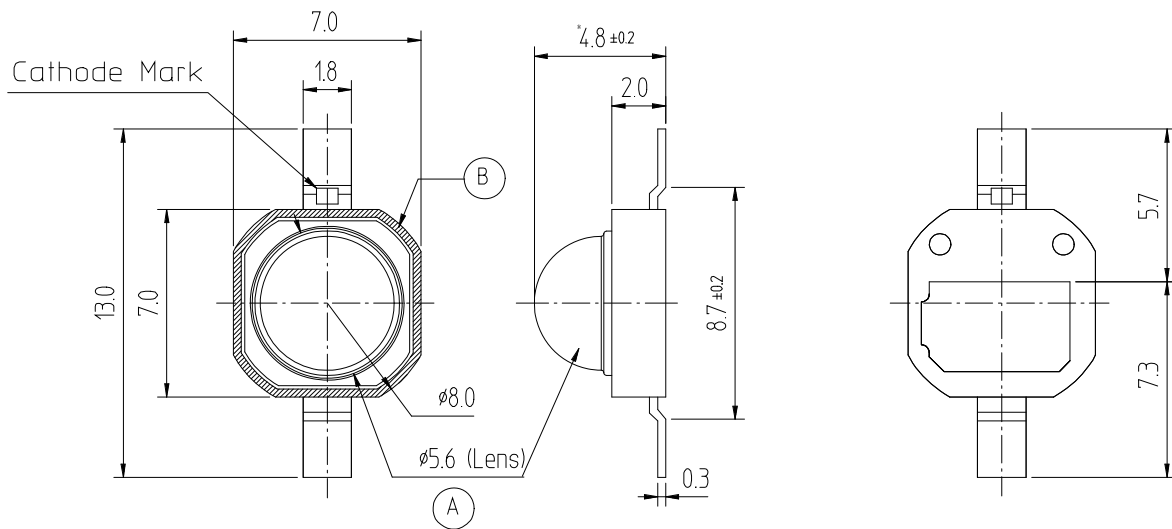

Pick and Place

1. Do not place pressure on the encapsulating resin ("A")
It is recommended to use a pick & place nozzle with inside diameter of 5.8mm
2. The maximum compressing force is 15N on the polymer ("B")

Circuit

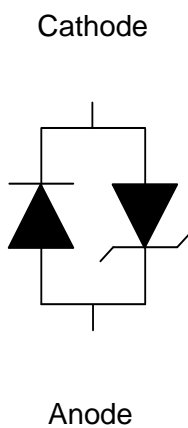

Solder Pattern for Surface Mount

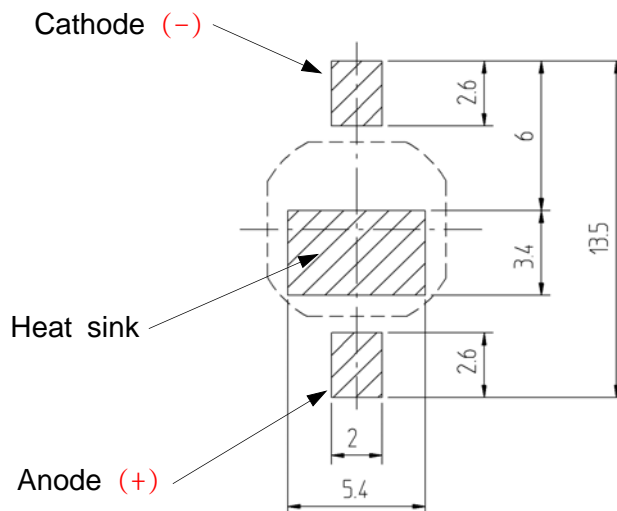

Remarks

Make sure that the heat sink is electrically connected to the Anode.
Heat sink is to be soldered, If not, use the heat conductive adhesive.

7. Package Structure

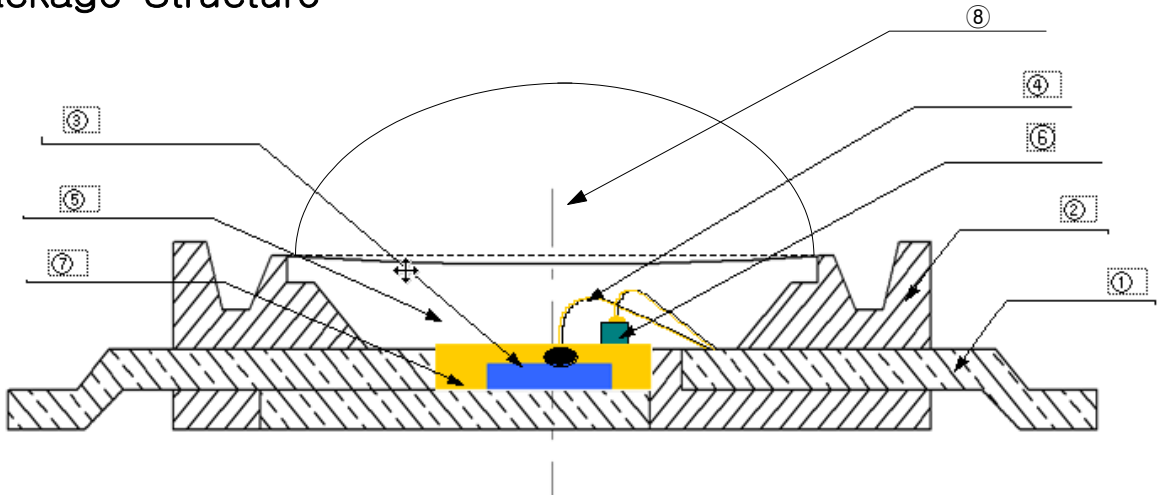

No	Component	Material
①	FRAME	Copper frame(Silver plated)
②	PACKAGE	Heat-resistant polymer
③	LED CHIP	GaN
④	WIRE	Gold wire
⑤	RESIN	Silicone
⑥	ZENER DIODE	Si
⑦	ENCAPSULATION RESIN	Silicone + Phosphor
⑧	LENS	Silicone

8. Solder Conditions

1) Reflow Conditions (Pb-Free)

Reflow Frequency : 2 time max.

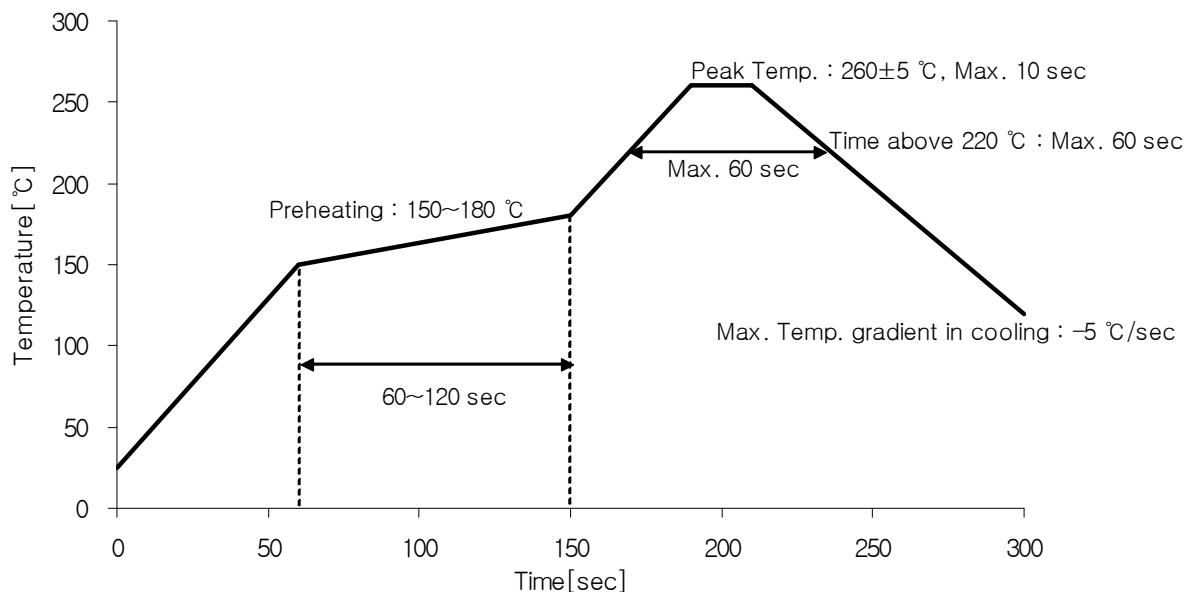

2) For Manual Soldering

Not more than 5 seconds @Max. 300 °C, under soldering iron.

9. Reliability Test Items and Conditions

1) Test Items

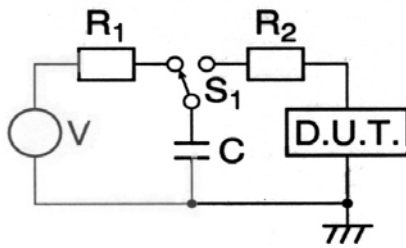
Test Items	Test Conditions	Test Hours/Cycles
Room Temperature life test	25 °C, $I_F = \text{Max DC}^*$	1,000 h
High Temperature humidity life test	85 °C, 60 % RH, $I_F = \text{Max DC}^*$	1,000 h
High Temperature life test	85 °C, $I_F = \text{Max DC}^*$	1,000 h
Low Temperature life test	-40 °C, $I_F = \text{Max DC}^*$	1,000 h
High Temperature Storage	110 °C	1,000 h
Low Temperature Storage	-40 °C	1,000 h
Thermal Shock	-40 / 120 °C, each 30 min	200 cycles
Temperature humidity Cycle On/Off test	-40 / 85 °C, each 20 min, 100 min transfer Power On/off each 5 min, DC 350 mA	100 cycles
Reflow (Pb-Free)	Peak 260±5 °C for 10 sec	3 times
ESD(HBM)	 <p>R1 : 10 MΩ , R2 : 1.5 kΩ , C : 100 pF</p>	3 times (± 5 kV)

* Max. DC current is depending on maximum current derating curve.

2) Criteria for Judging the Damage

Item	Symbol	Test Condition	Limit	
			Min	Max
Forward Voltage	V_F	$I_F = 350 \text{ mA}$	-	U.S.L.*1.2
Luminous Flux	Φ_V	$I_F = 350 \text{ mA}$	L.S.L.*0.5	-

* U.S.L : Upper Standard Level, L.S.L : Lower Standard Level

10. Taping Dimension

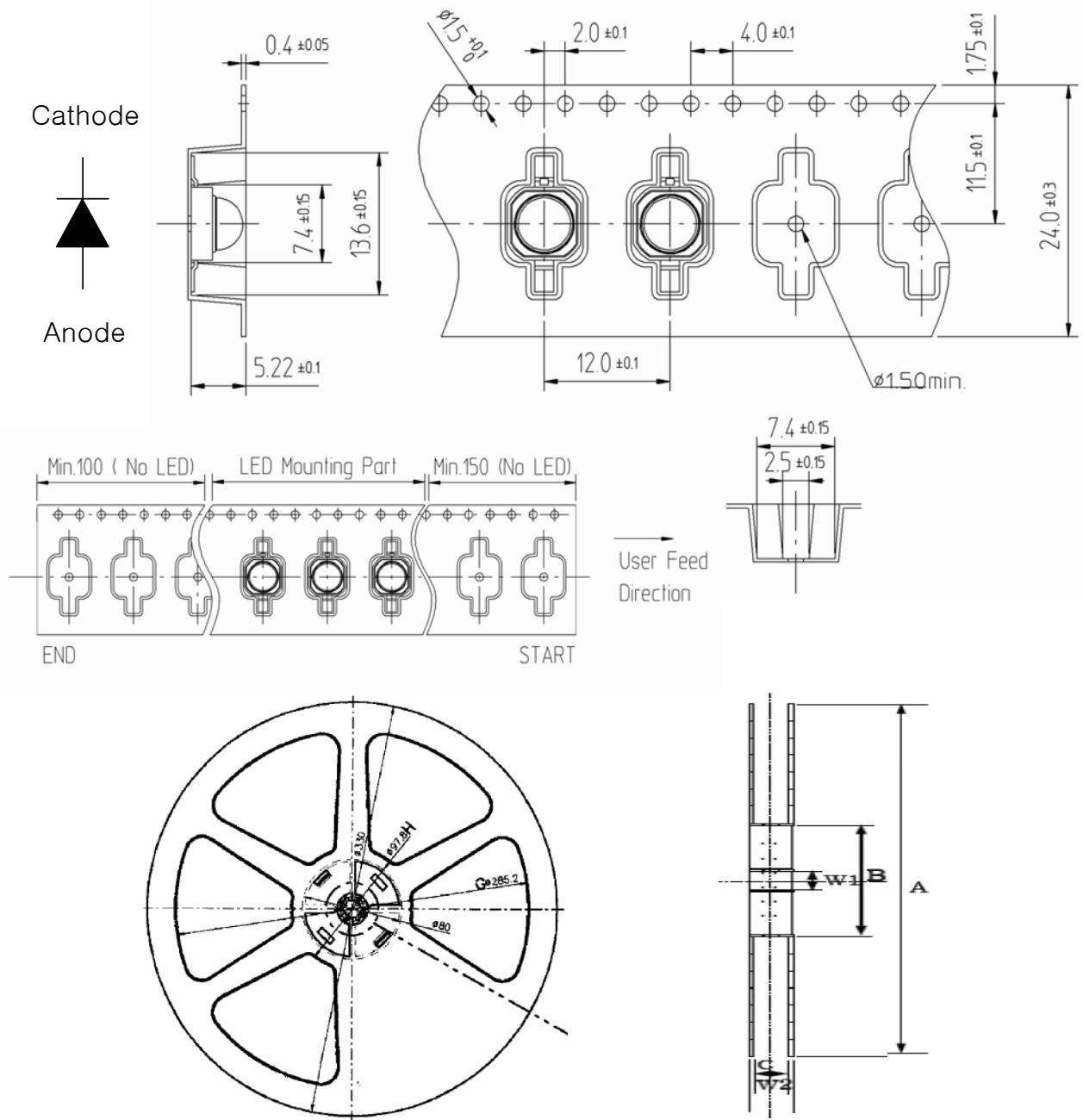

Symbol	A	B	C	W1	W2
Dimension(mm)	330 ± 1	80 ± 1	25 ± 0.5	13 ± 0.3	29.5 ± 1

- (1) Quantity : 1,000 Pcs / 13" Reel.
- (2) Cumulative Tolerance : Cumulative Tolerance/10 pitches is less than ±0.2 mm
- (3) Adhesion Strength of Cover Tape : Adhesion strength to be 0.1–0.7N when the cover tape is turned off from the carrier tape at 10 °C angle to be the carrier tape.
- (4) Packaging : P/N, Manufacturing data Code No. and quantity to be indicated on a damp proof Package

11. Label Structure

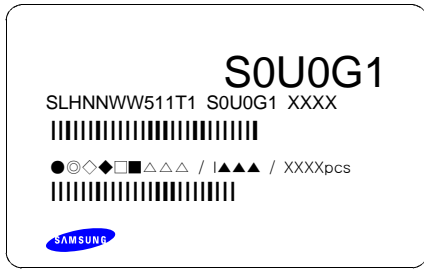

Rank Code

/S0/ : VF Rank (refer to page 3)

/U0/ : Chromaticity Coordinate Rank, CIE (refer to page 3)

/G1/ : Luminous Flux (refer to page 3)

12. Lot Number

The Lot number is composed of the following characters

●◎◇◆□■△△△ / |▲▲▲ / 1000PCS

● : Production Site (S:SAMSUNG LED, G:Gosin China)

◎ : L (LED)

◇ : Product State (A:Normality, B:Bulk, C:First Production, R:Reproduction, S:Sample)

◆ : Year (S:2008, T:2009, U:2010...)

□ : Month (1 ~ 9, A, B)

■ : Day (1 ~ 9, A, B ~ V)

△ : SAMSUNG LED Product Number (1 ~ 999)

▲ : Reel Number (1 ~ 999)

13. Reel Packing Structure

1) Reel

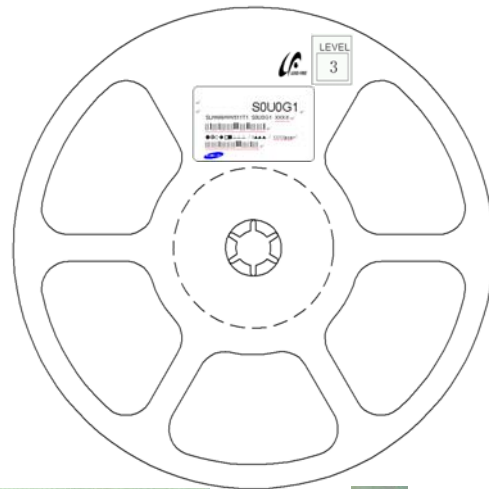
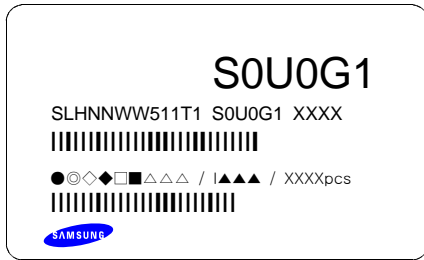

2) Aluminum Bag

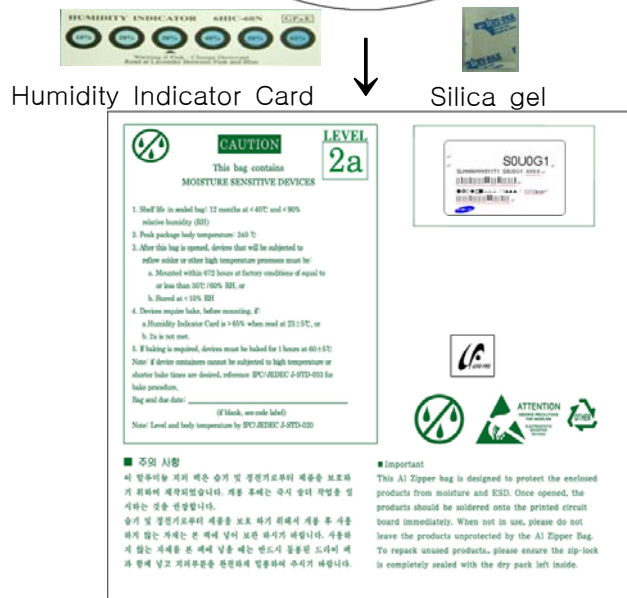
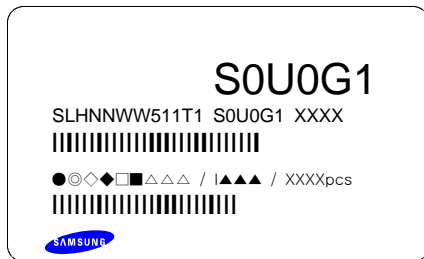

3) Inner Box

Material : Paper(SW3B(B))

TYPE	SIZE(mm)		
	L	W	H
13inch	335	45	335

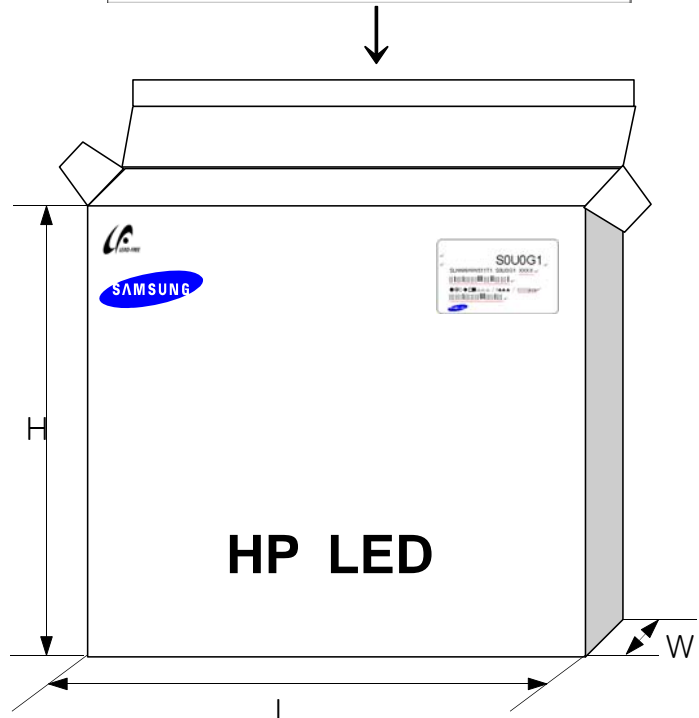
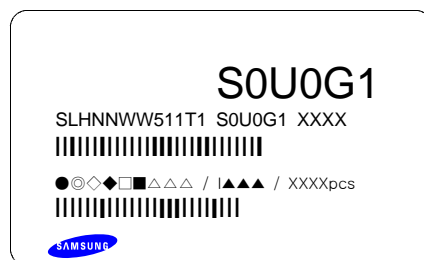

4) Carton Box

Material : Paper(SW3B(B))

TYPE	SIZE(mm)		
	L	W	H
13inch	350	350	350

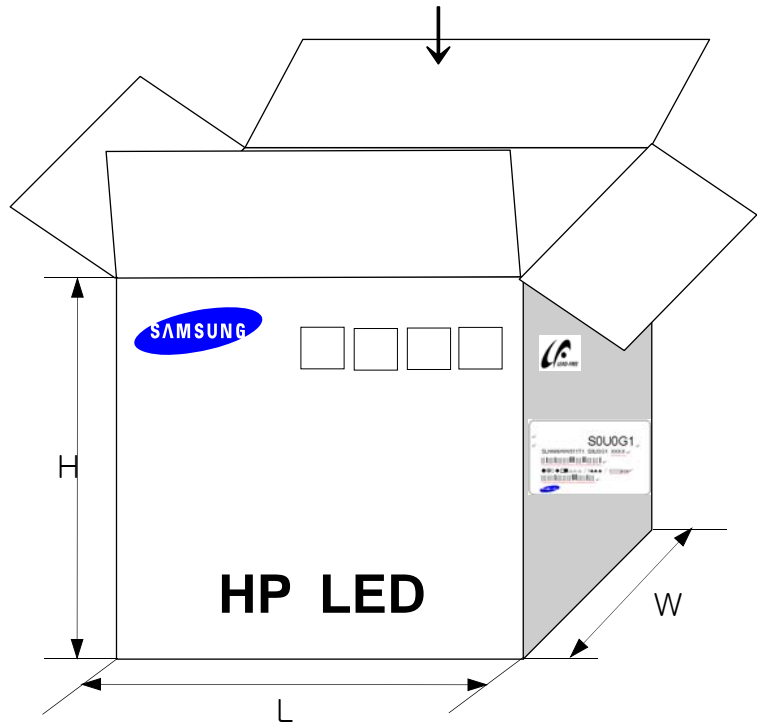
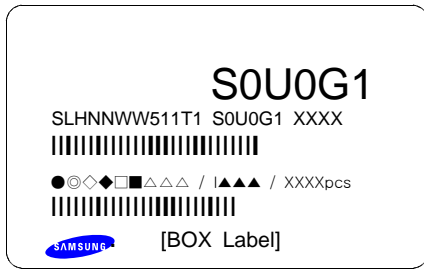

14. Precaution for Use

- 1) For over-current-proof function, customers are recommended to apply resistors to prevent sudden change of the current caused by slight shift of the voltage.
- 2) This device should not be used in any type of fluid such as water, oil, organic solvent, etc. When washing is required, IPA is recommended to use.
- 3) When the LEDs illuminate, operating current should be decided after considering the ambient maximum temperature.
- 4) LEDs must be stored in a clean environment. If the LEDs are to be stored for 3 months or more after being shipped from SAMSUNG LED, they should be packed by a sealed container with nitrogen gas injected. (Shelf life of sealed bags : 12 months, temp. 0~40°C, 20~70%RH)
- 5) After storage bag is open, device subjected to soldering, solder reflow, or other high temperature processes must be:
 - a. Mounted within 168 hours (7days) at an assembly line with a condition of no more than 30°C/60%RH,
 - b. Stored at <10% RH.
- 6) Repack unused Products with anti-moisture packing, fold to close any opening and then store in a dry place.
- 7) Devices require baking before mounting, if humidity card reading is >60% at 23±5°C.
- 8) Devices must be baked for 24hours at 65±5°C, if baking is required.
- 9) The LEDs are sensitive to the static electricity and surge. It is recommended to use a wrist band or anti-electrostatic glove when handling the LEDs.
 If voltage exceeding the absolute maximum rating is applied to LEDs, it may cause damage or even destruction to LED devices.
 Damaged LEDs may show some unusual characteristics such as increase in leak current, lowered turn-on voltage, or abnormal lighting of LEDs at low current.

- 10) When handling LED with tweezers, the LED Should only be held by the polymer body, not by the encapsulant or LENS.

- 11) The use of appropriate nozzle for the LED recommended. For the recommended nozzle size, refer to the figure at the below.

- 12) Do not stack assembled PCBs together. Since silicone is a soft material, abrasion between two PCB assembled with silicone encapsulated LED might cause catastrophic failure of the LEDs due to damage to encapsulant and wire and LED detachment.

15. Hazard Substance Analysis



Test Report No. F690501/LF-CTSAYAA08-20299

Issued Date: July 11, 2008

Page 1 of 3

To: SAMSUNG ELECTRO-MECHANICS CO., LTD.
314, Maetan3-dong
Yeongtong-gu
Suwon-city
GYEONGGI-DO 442-373
Korea

The following merchandise was submitted and identified by the client as :

Product Name : LED

SGS File No. : AYAA08-20299

Received Date : July 07, 2008

Test Performing Date : July 08, 2008

Test Performed : SGS Testing Korea tested the sample(s) selected by applicant with following results

Test Results : For further details, please refer to following page(s)

Comments : By the applicant's specific request, the sampling and testing was performed only for the part indicated in the photo without disassembly.

Pluto Kim
Monet Jeong
Billy Oh / Testing Person

SGS Testing Korea Co. Ltd.

Jeff Jang / Chemical Lab Mgr

This document is issued by the Company under its General Conditions of Service printed hereon or available on request and accessible at www.sgs.com. Attention is drawn to the limitation of liability, indemnification and jurisdiction issues defined therein. Any holder of this document is advised that information contained hereon reflects the Company's findings at the time of its intervention only and within the limits of Client's instructions, if any. The Company's sole responsibility is to its Client and this document does not exonerate parties to a transaction from exercising all their rights and obligations under the transaction documents. Any unauthorized alteration, forgery or falsification of the content or appearance of this document is unlawful and offenders may be prosecuted to the fullest extent of the law. Unless otherwise stated the results shown in this test report refer only to the sample(s) tested. This document cannot be reproduced except in full, without prior approval of the Company.

PO52 Version2

Test Report No. F690501/LF-CTSAYAA08-20299

Issued Date: July 11, 2008

Page 2 of 3
Sample No. : AYAA08-20299.001

Sample Description : LED

Item No./Part No. : 7070 LENS(RGY)

Heavy Metals

Test Items	Unit	Test Method	MDL	Results
Cadmium (Cd)	mg/kg	US EPA 3052(1996), US EPA 6010B(1996), ICP	0.5	N.D.
Lead (Pb)	mg/kg	US EPA 3052(1996), US EPA 6010B(1996), ICP	5	N.D.
Mercury (Hg)	mg/kg	US EPA 3052(1996), US EPA 6010B(1996), ICP	2	N.D.
Hexavalent Chromium (Cr VI)	mg/kg	US EPA 3060A(1996), US EPA 7196A(1992), UV	1	N.D.

Flame Retardants-PBBs/PBDEs

Test Items	Unit	Test Method	MDL	Results
Monobromobiphenyl	mg/kg	US EPA 3540C, GC/MS	5	N.D.
Dibromobiphenyl	mg/kg	US EPA 3540C, GC/MS	5	N.D.
Tribromobiphenyl	mg/kg	US EPA 3540C, GC/MS	5	N.D.
Tetrabromobiphenyl	mg/kg	US EPA 3540C, GC/MS	5	N.D.
Pentabromobiphenyl	mg/kg	US EPA 3540C, GC/MS	5	N.D.
Hexabromobiphenyl	mg/kg	US EPA 3540C, GC/MS	5	N.D.
Heptabromobiphenyl	mg/kg	US EPA 3540C, GC/MS	5	N.D.
Octabromobiphenyl	mg/kg	US EPA 3540C, GC/MS	5	N.D.
Nonabromobiphenyl	mg/kg	US EPA 3540C, GC/MS	5	N.D.
Decabromobiphenyl	mg/kg	US EPA 3540C, GC/MS	5	N.D.
Monobromodiphenyl ether	mg/kg	US EPA 3540C, GC/MS	5	N.D.
Dibromodiphenyl ether	mg/kg	US EPA 3540C, GC/MS	5	N.D.
Tribromodiphenyl ether	mg/kg	US EPA 3540C, GC/MS	5	N.D.
Tetrabromodiphenyl ether	mg/kg	US EPA 3540C, GC/MS	5	N.D.
Pentabromodiphenyl ether	mg/kg	US EPA 3540C, GC/MS	5	N.D.
Hexabromodiphenyl ether	mg/kg	US EPA 3540C, GC/MS	5	N.D.
Heptabromodiphenyl ether	mg/kg	US EPA 3540C, GC/MS	5	N.D.
Octabromodiphenyl ether	mg/kg	US EPA 3540C, GC/MS	5	N.D.
Nonabromodiphenyl ether	mg/kg	US EPA 3540C, GC/MS	5	N.D.
Decabromodiphenyl ether	mg/kg	US EPA 3540C, GC/MS	5	N.D.

- NOTE:
- (1) N.D. = Not detected. (<MDL)
 - (2) mg/kg = ppm
 - (3) MDL = Method Detection Limit
 - (4) - = No regulation
 - (5) ** = Qualitative analysis (No Unit)
 - (6) Negative = Undetectable / Positive = Detectable

This document is issued by the Company under its General Conditions of Service printed hereof or available on request and accessible at http://www.sgs.com/conditions_of_service. Attention is drawn to the limitation of liability, indemnification and jurisdiction issues defined therein. Any holder of this document is advised that information contained herein reflects the Company's findings at the time of its intervention only and within the limits of Client's instructions, if any. The Company's sole responsibility is to its Client and this document does not exonerate parties to a transaction from ascertaining all their rights and obligations under the transaction documents. Any unauthorized alteration, forgery or falsification of the content or appearance of this document is unlawful and offenders may be prosecuted to the fullest extent of the law. Unless otherwise stated the results shown in this test report refer only to the sample(s) tested. This document cannot be reproduced except in full, without prior approval of the Company.

F052 Version2



Test Report No. F690501/LF-CTSAYAA08-20299

Issued Date: July 11, 2008

Page 3 of 3

Sample No. : AYAA08-20299.001

Sample Description : LED

Item No./Part No. : 7070 LENS(RGY)

Halogen Contents

Test Items	Unit	Test Method	MDL	Results
Fluorine(F)	mg/kg	EN 14582:2007 , IC	30	N.D.
Bromine(Br)	mg/kg	EN 14582:2007 , IC	30	N.D.
Chlorine(Cl)	mg/kg	EN 14582:2007 , IC	30	N.D.
Iodine(I)	mg/kg	EN 14582:2007 , IC	30	N.D.



*** End ***

- NOTE:
- (1) N.D. = Not detected.(<MDL)
 - (2) mg/kg = ppm
 - (3) MDL = Method Detection Limit
 - (4) - = No regulation
 - (5) ** = Qualitative analysis (No Unit)
 - (6) Negative = Undetectable / Positive = Detectable

This document is issued by the Company under its General Conditions of Service printed hereon or available on request and accessible at <http://www.sgs.com/sgsweb>. Attention is drawn to the limitation of liability, indemnification and jurisdiction issues defined therein. Any holder of this document is advised the information contained herein reflects the Company's findings at the time of its intervention only and within the limits of Client's instructions, if any. The Company's sole responsibility is to its Client and this document does not exonerate parties to a transaction from ascertaining all their rights and obligations under the transaction documents. Any unauthorized alteration, forgery or falsification of the content or appearance of this document is unlawful and offenders may be prosecuted to the fullest extent of the law. Unless otherwise stated the results shown in this test report refer only to the sample(s) tested. This document cannot be reproduced except in full, without prior approval of the Company.

