

TOSHIBA BI-DIRECTIONAL TRIODE THYRISTOR SILICON PLANAR TYPE

# SM25GZ51, SM25JZ51

AC POWER CONTROL APPLICATIONS

Unit in mm

- Repetitive Peak Off-State Voltage :  $V_{DRM}=400, 600V$
- R.M.S On-State Current :  $I_T(RMS)=25A$
- High Commutating (dv/dt) :  $(dv/dt)c=10V/\mu s$
- Isolation Voltage :  $V_{Isol}=1500V AC$

**MAXIMUM RATINGS**

CHARACTERISTIC		SYMBOL	RATING	UNIT
Repetitive Peak Off-State Voltage	SM25GZ51	$V_{DRM}$	400	V
	SM25JZ51		600	
R.M.S On-State Current (Full Sine Waveform $T_c=73^\circ C$ )		$I_T(RMS)$	25	A
Peak One Cycle Surge On-State Current (Non-Repetitive)		$I_{TSM}$	230 (50Hz)	A
			253 (60Hz)	
I <sup>2</sup> t Limit Value		$I^2t$	260	A <sup>2</sup> s
Critical Rate of Rise of On-State Current (Note 1)		di/dt	50	A/μs
Peak Gate Power Dissipation		$P_{GM}$	5	W
Average Gate Power Dissipation		$P_G(AV)$	0.5	W
Peak Gate Voltage		$V_{GM}$	10	V
Peak Gate Current		$I_{GM}$	2	A
Junction Temperature		$T_j$	-40~125	°C
Storage Temperature Range		$T_{stg}$	-40~125	°C
Isolation Voltage (AC, t=1 min.)		$V_{Isol}$	1500	V

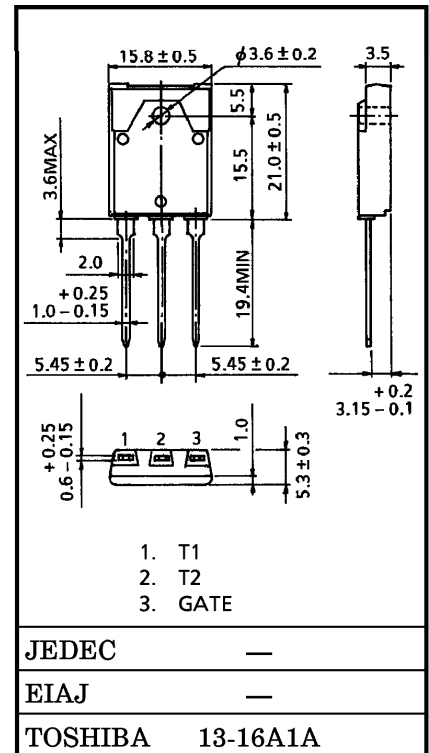

Weight : 5.9g

Note 1 : di/dt Test Condition

$$V_{DRM} = 0.5 \times \text{Rated}$$

$$I_{TM} \leq 40A$$

$$t_{gw} \geq 10\mu s$$

$$t_{gr} \leq 250ns$$

$$i_{gp} = I_{GT} \times 2.0$$

961001EAA1

- TOSHIBA is continually working to improve the quality and the reliability of its products. Nevertheless, semiconductor devices in general can malfunction or fail due to their inherent electrical sensitivity and vulnerability to physical stress. It is the responsibility of the buyer, when utilizing TOSHIBA products, to observe standards of safety, and to avoid situations in which a malfunction or failure of a TOSHIBA product could cause loss of human life, bodily injury or damage to property. In developing your designs, please ensure that TOSHIBA products are used within specified operating ranges as set forth in the most recent products specifications. Also, please keep in mind the precautions and conditions set forth in the TOSHIBA Semiconductor Reliability Handbook.
- The information contained herein is presented only as a guide for the applications of our products. No responsibility is assumed by TOSHIBA CORPORATION for any infringements of intellectual property or other rights of the third parties which may result from its use. No license is granted by implication or otherwise under any intellectual property or other rights of TOSHIBA CORPORATION or others.
- The information contained herein is subject to change without notice.

ELECTRICAL CHARACTERISTICS (Ta = 25°C)

CHARACTERISTIC	SYMBOL	TEST CONDITION	MIN.	TYP.	MAX.	UNIT	
Repetitive Peak Off-State Current	$I_{DRM}$	$V_{DRM} = \text{Rated}$	—	—	20	$\mu\text{A}$	
Gate Trigger Voltage	I II III $V_{GT}$	$V_D = 12\text{V}$ $R_L = 20\Omega$	T2(+), GATE(+)	—	—	1.5	V
			T2(+), GATE(-)	—	—	1.5	
			T2(-), GATE(-)	—	—	1.5	
Gate Trigger Current	I II III $I_{GT}$	$V_D = 12\text{V}$ $R_L = 20\Omega$	T2(+), GATE(+)	—	—	30	mA
			T2(+), GATE(-)	—	—	30	
			T2(-), GATE(-)	—	—	30	
Peak On-State Voltage	$V_{TM}$	$I_{TM} = 40\text{A}$	—	—	1.5	V	
Gate Non-Trigger Voltage	$V_{GD}$	$V_D = \text{Rated}, T_c = 125^\circ\text{C}$	0.2	—	—	V	
Holding Current	$I_H$	$V_D = 12\text{V}, I_{TM} = 1\text{A}$	—	—	60	mA	
Thermal Resistance	$R_{th(j-c)}$	Junction to Case, AC	—	—	1.3	$^\circ\text{C}/\text{W}$	
Critical Rate of Rise of Off-State Voltage	$dv/dt$	$V_{DRM} = \text{Rated}, T_j = 125^\circ\text{C}$ Exponential Rise	—	300	—	$\text{V}/\mu\text{s}$	
Critical Rate of Rise of Off-State Voltage at Commutation	$(dv/dt)_c$	$V_{DRM} = 400\text{V}, T_j = 125^\circ\text{C}$ $(di/dt)_c = -15\text{A}/\text{ms}$	10	—	—	$\text{V}/\mu\text{s}$	

MARKING

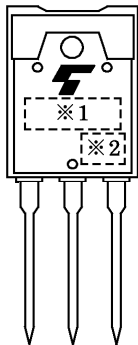

NUMBER	SYMBOL	MARK
※ 1	TYPE	SM25GZ51
		SM25JZ51
※ 2	Lot Number <div style="display: flex; align-items: center;"> <div style="border: 1px solid black; width: 15px; height: 15px; margin-right: 5px;"></div> <div style="border: 1px solid black; width: 15px; height: 15px; margin-right: 5px; margin-left: 5px;"></div> <div style="margin-left: 5px;"> <p>Month (Starting from Alphabet A)</p> <p>Year (Last Decimal Digit of the Current Year)</p> </div> </div>	Example 8A : January 1998 8B : February 1998 8L : December 1998

GATE TRIGGER CHARACTERISTIC

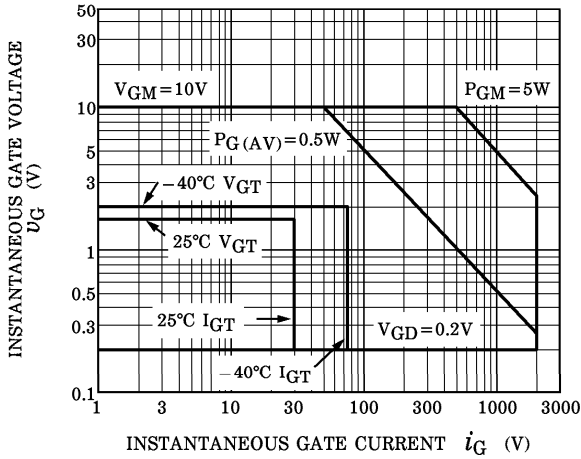

SURGE ON-STATE CURRENT (NON-REPETITIVE)

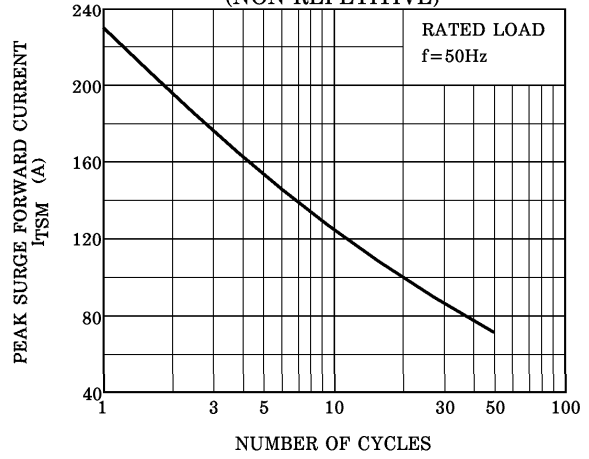

$i_T - U_T$

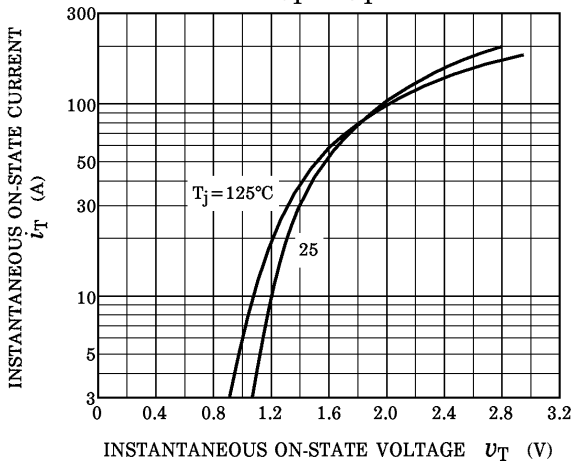

$I_{GT}(T_c) / I_{GT}(T_c=25^\circ C) - T_c$  (TYPICAL)

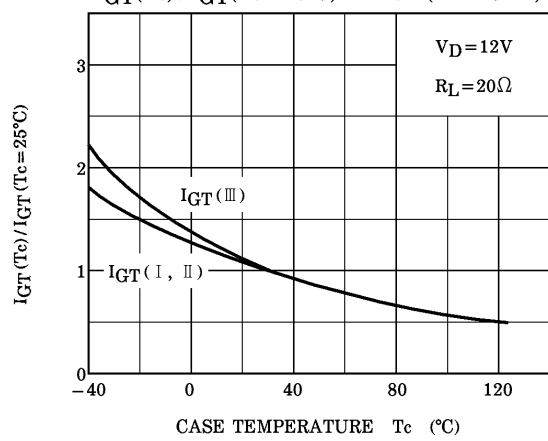

$V_{GT}(T_c) / V_{GT}(T_c=25^\circ C) - T_c$  (TYPICAL)

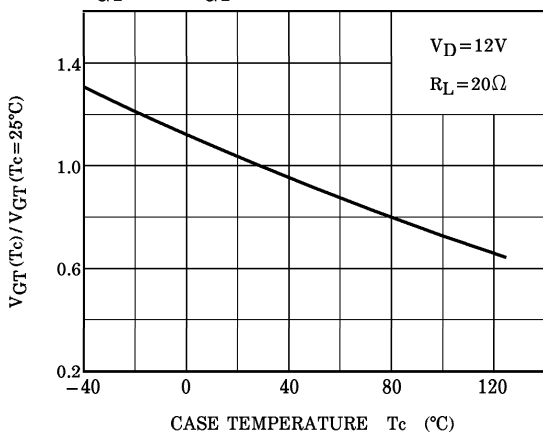

$I_H(T_c) / I_H(T_c=25^\circ C) - T_c$  (TYPICAL)

