



# STGF10NB60SD

N-channel 10A - 600V - TO-220FP  
PowerMESH™ IGBT

## General features

Type	V <sub>CES</sub>	V <sub>CE(sat)</sub> (Max)@ 25°C	I <sub>C</sub> @100°C
STGF10NB60SD	600V	<1.8V	7A

- High input impedance (voltage driven)
- Low on-voltage drop
- High current capability
- Co-packaged with turboswitch™ antiparallel diode

## Description

Using the latest high voltage technology based on a patented strip layout, STMicroelectronics has designed an advanced family of IGBTs, the PowerMESH™ IGBTs, with outstanding performances. The suffix “S” identifies a family optimized achieve minimum on-voltage drop for low frequency applications (<1kHz).

## Applications

- Light dimmer
- Static relays
- Motor control

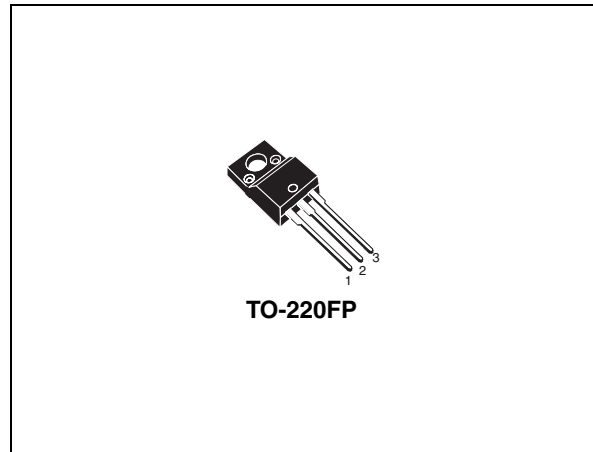

## Internal schematic diagram

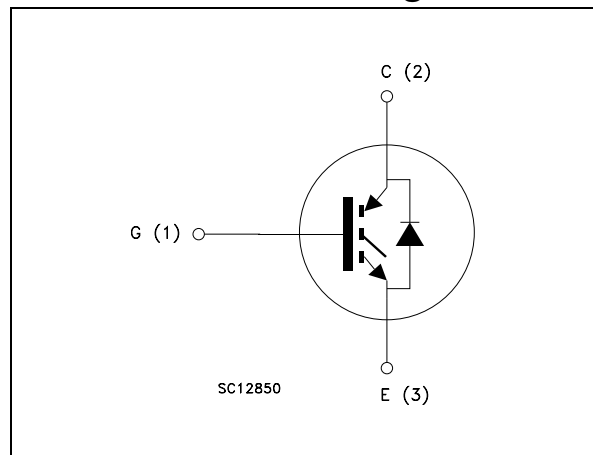

## Order codes

Part number	Marking	Package	Packaging
STGF10NB60SD	GF10NB60SD	TO-220FP	Tube

# Contents

<b>1</b>	<b>Electrical ratings</b> .....	<b>3</b>
<b>2</b>	<b>Electrical characteristics</b> .....	<b>4</b>
	2.1 Electrical characteristics (curves) .....	6
<b>3</b>	<b>Test circuit</b> .....	<b>9</b>
<b>4</b>	<b>Package mechanical data</b> .....	<b>10</b>
<b>5</b>	<b>Revision history</b> .....	<b>12</b>

# 1 Electrical ratings

**Table 1. Absolute maximum ratings**

Symbol	Parameter	Value	Unit
$V_{CES}$	Collector-emitter voltage ( $V_{GS} = 0$ )	600	V
$I_C$	Collector current (continuous) at 25°C	20	A
$I_C$	Collector current (continuous) at 100°C	7	A
$I_{CM}^{(1)}$	Collector current (pulsed)	100	A
$V_{GE}$	Gate-emitter voltage	$\pm 20$	V
$P_{TOT}$	Total dissipation at $T_C = 25^\circ\text{C}$	25	W
$V_{ISO}$	Insulation withstand voltage A.C.(t = 1sec; $T_C=25^\circ\text{C}$ )	2500	V
$T_{stg}$	Operating junction temperature	- 55 to 150	°C
$T_j$	Storage temperature		

1. Pulse width limited by max. junction temperature.

**Table 2. Thermal resistance**

Symbol	Parameter	Value	Unit
Rthj-case	Thermal resistance junction-case Max	5	°C/W
Rthj-amb	Thermal resistance junction-ambient Max	62.5	°C/W

## 2 Electrical characteristics

( $T_{CASE}=25^{\circ}\text{C}$  unless otherwise specified)

**Table 3. Static**

Symbol	Parameter	Test conditions	Min.	Typ.	Max.	Unit
$V_{BR(CES)}$	Collector-emitter breakdown voltage	$I_C = 250\mu\text{A}, V_{GE} = 0$	600			V
$V_{BR(CES)}$	Collector-emitter breakdown voltage	$I_C = 1\text{mA}, V_{GE} = 0$	20			V
$V_{CE(SAT)}$	Collector-emitter saturation voltage	$V_{GE} = 15\text{V}, I_C = 5\text{A}, T_j = 25^{\circ}\text{C}$		1.15		V
		$V_{GE} = 15\text{V}, I_C = 10\text{A}, T_j = 25^{\circ}\text{C}$		1.35	1.8	V
		$V_{GE} = 15\text{V}, I_C = 10\text{A}, T_j = 125^{\circ}\text{C}$		1.25		V
$V_{GE(th)}$	Gate threshold voltage	$V_{CE} = V_{GE}, I_C = 250\mu\text{A}$	2.5		5	V
$I_{CES}$	Collector-emitter leakage current ( $V_{CE} = 0$ )	$V_{CE} = \text{Max rating}, T_j = 25^{\circ}\text{C}$			10	$\mu\text{A}$
		$V_{CE} = \text{Max rating}, T_j = 125^{\circ}\text{C}$			100	$\mu\text{A}$
$I_{GES}$	Gate-emitter leakage current ( $V_{CE} = 0$ )	$V_{GE} = \pm 20\text{V}, V_{CE} = 0$			$\pm 100$	nA
$g_{fs}$	Forward transconductance	$V_{CE} = 25\text{V}, I_C = 10\text{A}$	5			S

**Table 4. Dynamic**

Symbol	Parameter	Test conditions	Min.	Typ.	Max.	Unit
$C_{ies}$ $C_{oes}$ $C_{res}$	Input capacitance Output capacitance Reverse transfer capacitance	$V_{CE} = 25\text{V}, f = 1\text{MHz}, V_{GE} = 0$		610		pF
				65		pF
				12		pF
$Q_g$	Total gate charge	$V_{CE} = 400\text{V}, I_C = 10\text{A}, V_{GE} = 15\text{V}$		33		nC
$I_{CL}$	Turn-off SOA minimum current	$V_{clamp} = 480\text{V}, R_G = 1\text{k}\Omega, T_j = 125^{\circ}\text{C}$	20			A

**Table 5. Switching on/off (inductive load)**

Symbol	Parameter	Test conditions	Min.	Typ.	Max.	Unit
$t_{d(on)}$	Turn-on delay time	$V_{CC} = 480\text{ V}$ , $I_C = 10\text{ A}$ $R_G = 1\text{ K}\Omega$ , $V_{GE} = 15\text{ V}$ $T_J = 25^\circ\text{C}$ (see Figure 15)		0.7		$\mu\text{s}$
$t_r$	Current rise time			0.46		$\mu\text{s}$
$(di/dt)_{on}$	Turn-on current slope				8	$\text{A}/\mu\text{s}$
$E_{on}^{(1)}$	Turn-on switching losses				0.6	mJ
$t_r(V_{off})$	Off voltage rise time	$V_{CC} = 480\text{ V}$ , $I_C = 10\text{ A}$ $R_G = 1\text{ K}\Omega$ , $V_{GE} = 15\text{ V}$ $T_J = 25^\circ\text{C}$ (see Figure 15)		2.2		$\mu\text{s}$
$t_{d(off)}$	Turn-off delay time			1.2		$\mu\text{s}$
$t_f$	Current fall time				1.2	$\mu\text{s}$
$E_{off}^{(2)}$	Turn-off switching losses				5.0	mJ
$t_r(V_{off})$	Off voltage rise time	$V_{CC} = 480\text{ V}$ , $I_C = 10\text{ A}$ $R_G = 1\text{ K}\Omega$ , $V_{GE} = 15\text{ V}$ $T_J = 125^\circ\text{C}$ (see Figure 15)		3.8		$\mu\text{s}$
$t_{d(off)}$	Turn-off delay time			1.2		$\mu\text{s}$
$t_f$	Current fall time				1.9	$\mu\text{s}$
$E_{off}^{(2)}$	Turn-off switching losses				8.0	mJ

1.  $E_{on}$  is the turn-on losses when a typical diode is used in the test circuit in figure 2  $E_{on}$  include diode recovery energy. If the IGBT is offered in a package with a co-pak diode, the co-pak diode is used as external diode. IGBTs & Diode are at the same temperature ( $25^\circ\text{C}$  and  $125^\circ\text{C}$ )

2. Turn-off losses include also the tail of the collector current

**Table 6. Collector-emitter diode**

Symbol	Parameter	Test conditions	Min	Typ.	Max	Unit
$I_f$	Forward current				7	A
$I_{fm}$	Forward current pulsed				56	A
$V_f$	Forward on-voltage	$I_f = 3.5\text{ A}$		1.4	1.9	V
		$I_f = 3.5\text{ A}$ , $T_J = 125^\circ\text{C}$		1.15		V
$t_{rr}$	Reverse recovery time	$I_f = 7\text{ A}$ , $V_R = 20\text{ V}$ , $T_J = 125^\circ\text{C}$ , $di/dt = 100\text{ A}/\mu\text{s}$ (see Figure 18)		50		ns
$Q_{rr}$	Reverse recovery charge			70		nC
$I_{rrm}$	Reverse recovery current				2.7	

## 2.1 Electrical characteristics (curves)

Figure 1. Output characteristics

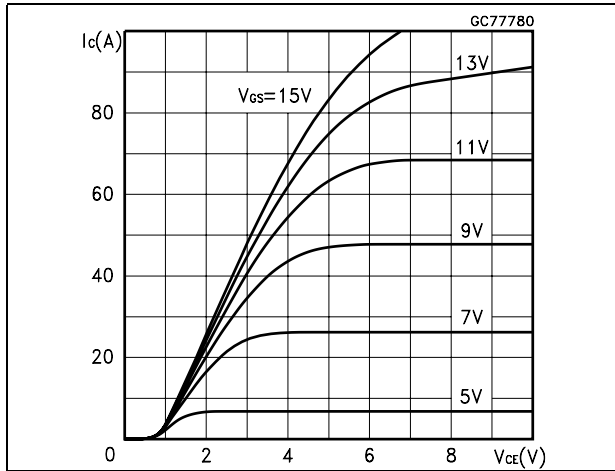

Figure 2. Transfer characteristics

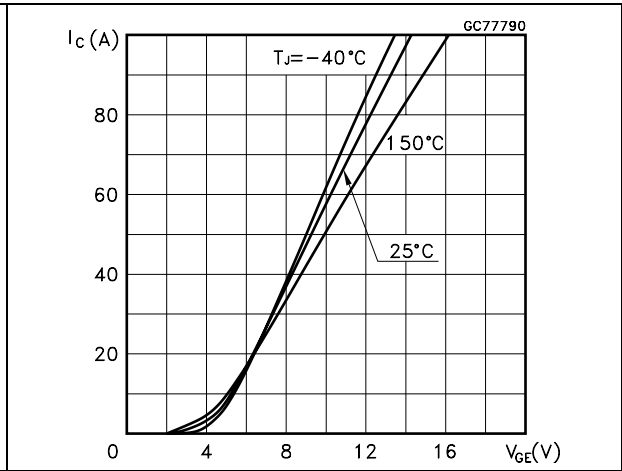

Figure 3. Transconductance

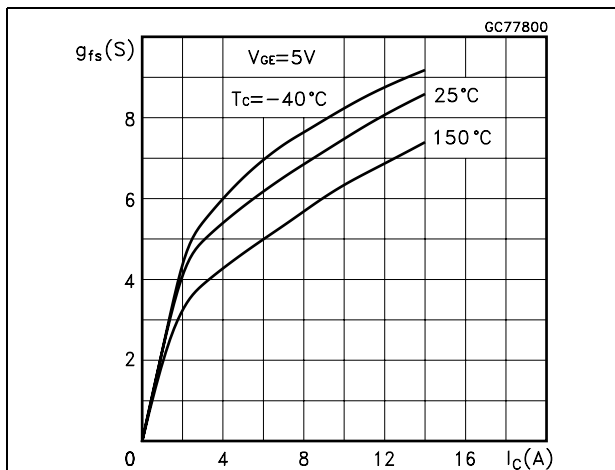

Figure 4. Collector-emitter on voltage vs temperature

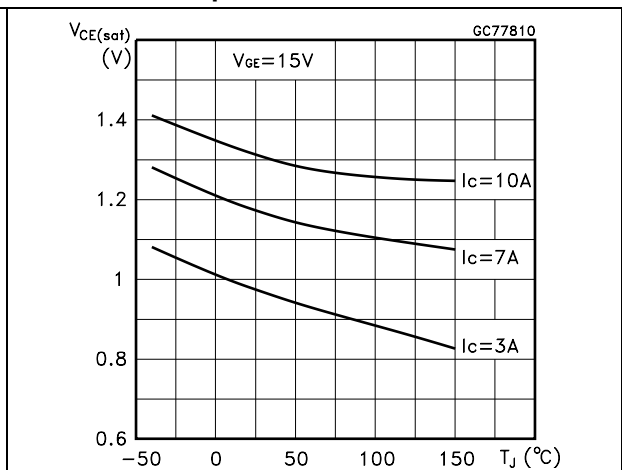

Figure 5. Collector-emitter on voltage vs collector current

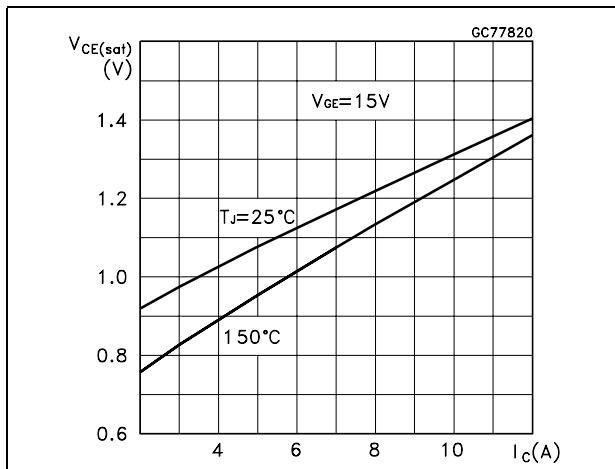

Figure 6. Normalized gate threshold vs temperature

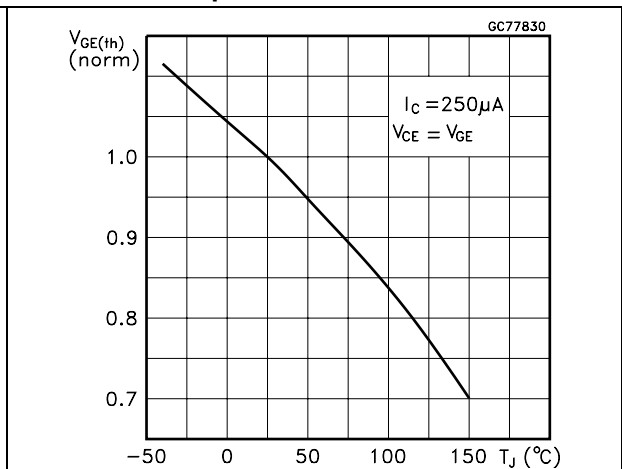

Figure 7. Normalized breakdown voltage vs temperature

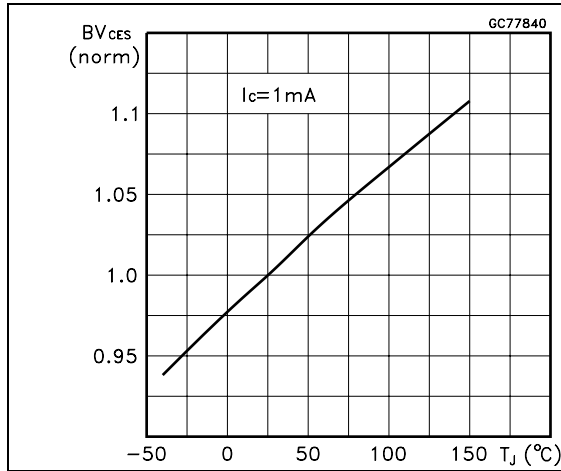

Figure 8. Gate charge vs gate-emitter voltage

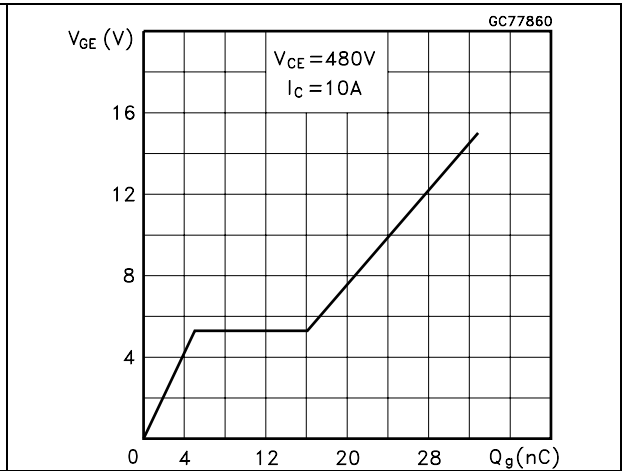

Figure 9. Capacitance variations

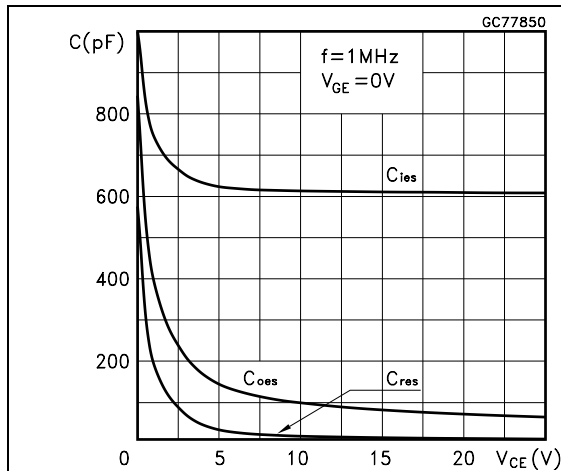

Figure 10. Switching losses vs temperature

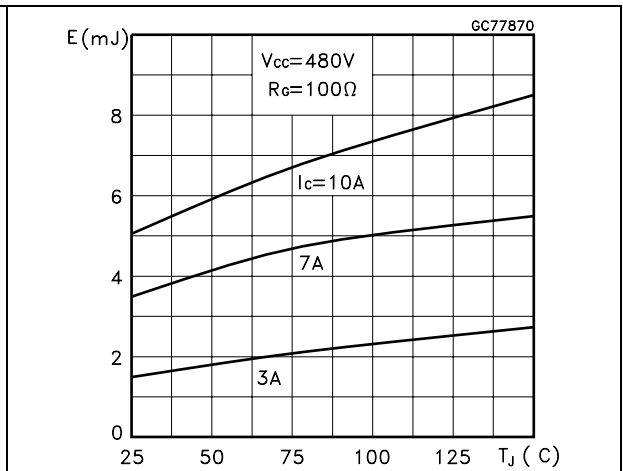

Figure 11. Switching losses vs gate resistance

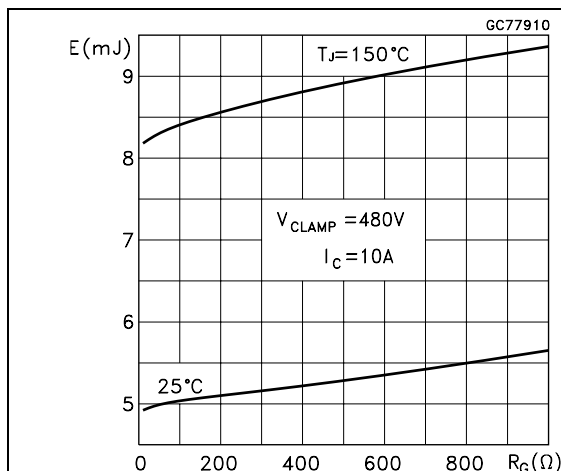

Figure 12. Switching losses vs collector current

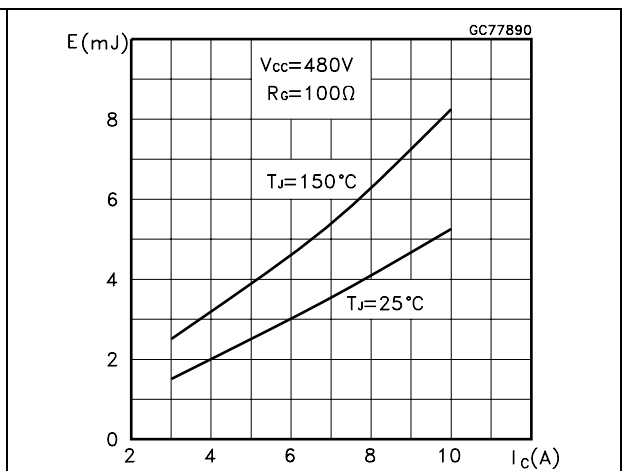

Figure 13. Thermal impedance

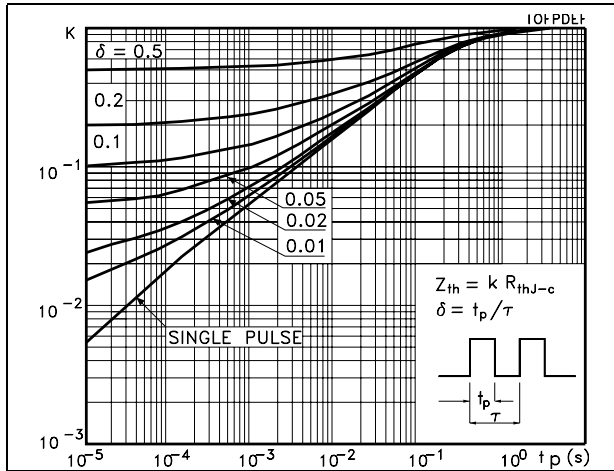
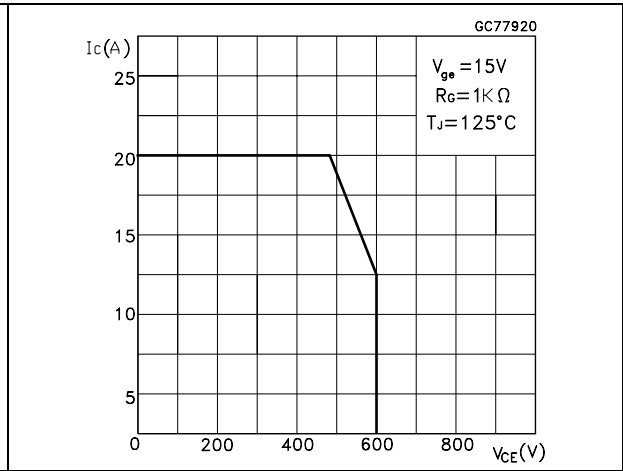

Figure 14. Turn-off SOA





### 3 Test circuit

Figure 15. Test circuit for inductive load switching

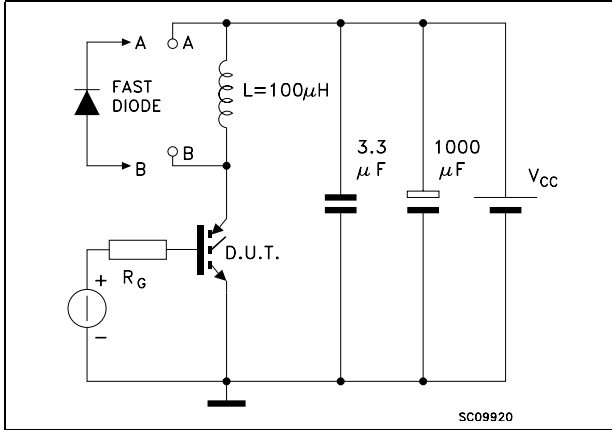

Figure 16. Gate charge test circuit

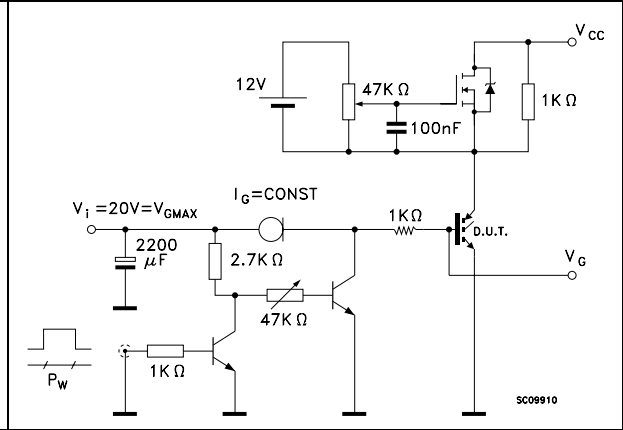

Figure 17. Switching waveforms

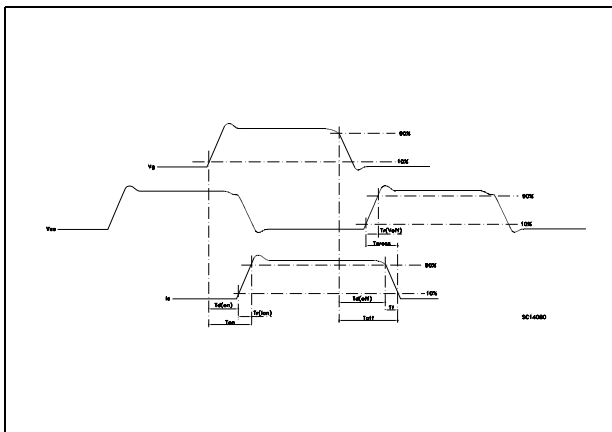
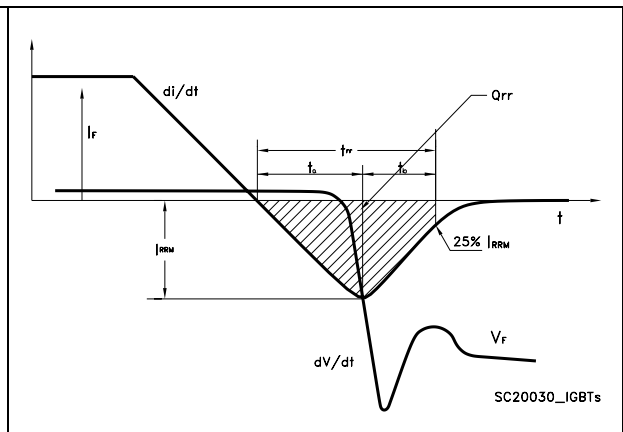

Figure 18. Diode recovery times waveform



## 4 Package mechanical data

In order to meet environmental requirements, ST offers these devices in ECOPACK® packages. These packages have a Lead-free second level interconnect . The category of second level interconnect is marked on the package and on the inner box label, in compliance with JEDEC Standard JESD97. The maximum ratings related to soldering conditions are also marked on the inner box label. ECOPACK is an ST trademark. ECOPACK specifications are available at: [www.st.com](http://www.st.com)

## TO-220FP MECHANICAL DATA

DIM.	mm.			inch		
	MIN.	TYP.	MAX.	MIN.	TYP.	MAX.
A	4.4		4.6	0.173		0.181
B	2.5		2.7	0.098		0.106
D	2.5		2.75	0.098		0.108
E	0.45		0.7	0.017		0.027
F	0.75		1	0.030		0.039
F1	1.15		1.7	0.045		0.067
F2	1.15		1.7	0.045		0.067
G	4.95		5.2	0.195		0.204
G1	2.4		2.7	0.094		0.106
H	10		10.4	0.393		0.409
L2		16			0.630	
L3	28.6		30.6	1.126		1.204
L4	9.8		10.6	.0385		0.417
L5	2.9		3.6	0.114		0.141
L6	15.9		16.4	0.626		0.645
L7	9		9.3	0.354		0.366
Ø	3		3.2	0.118		0.126

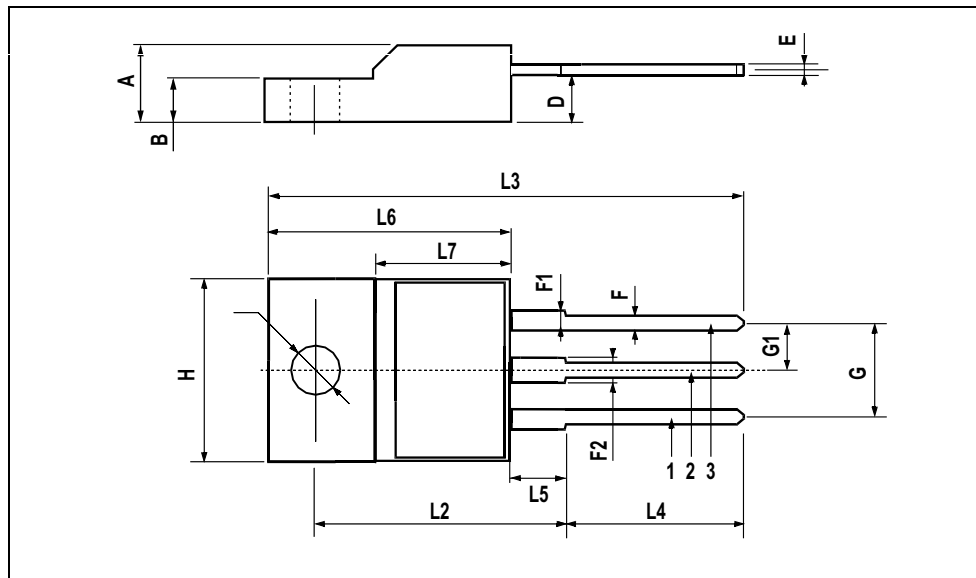

## 5 Revision history

Table 7. Revision history

Date	Revision	Changes
15-May-2006	2	New template

**Please Read Carefully:**

Information in this document is provided solely in connection with ST products. STMicroelectronics NV and its subsidiaries ("ST") reserve the right to make changes, corrections, modifications or improvements, to this document, and the products and services described herein at any time, without notice.

All ST products are sold pursuant to ST's terms and conditions of sale.

Purchasers are solely responsible for the choice, selection and use of the ST products and services described herein, and ST assumes no liability whatsoever relating to the choice, selection or use of the ST products and services described herein.

No license, express or implied, by estoppel or otherwise, to any intellectual property rights is granted under this document. If any part of this document refers to any third party products or services it shall not be deemed a license grant by ST for the use of such third party products or services, or any intellectual property contained therein or considered as a warranty covering the use in any manner whatsoever of such third party products or services or any intellectual property contained therein.

**UNLESS OTHERWISE SET FORTH IN ST'S TERMS AND CONDITIONS OF SALE ST DISCLAIMS ANY EXPRESS OR IMPLIED WARRANTY WITH RESPECT TO THE USE AND/OR SALE OF ST PRODUCTS INCLUDING WITHOUT LIMITATION IMPLIED WARRANTIES OF MERCHANTABILITY, FITNESS FOR A PARTICULAR PURPOSE (AND THEIR EQUIVALENTS UNDER THE LAWS OF ANY JURISDICTION), OR INFRINGEMENT OF ANY PATENT, COPYRIGHT OR OTHER INTELLECTUAL PROPERTY RIGHT.**

**UNLESS EXPRESSLY APPROVED IN WRITING BY AN AUTHORIZED REPRESENTATIVE OF ST, ST PRODUCTS ARE NOT DESIGNED, AUTHORIZED OR WARRANTED FOR USE IN MILITARY, AIR CRAFT, SPACE, LIFE SAVING, OR LIFE SUSTAINING APPLICATIONS, NOR IN PRODUCTS OR SYSTEMS, WHERE FAILURE OR MALFUNCTION MAY RESULT IN PERSONAL INJURY, DEATH, OR SEVERE PROPERTY OR ENVIRONMENTAL DAMAGE.**

Resale of ST products with provisions different from the statements and/or technical features set forth in this document shall immediately void any warranty granted by ST for the ST product or service described herein and shall not create or extend in any manner whatsoever, any liability of ST.

ST and the ST logo are trademarks or registered trademarks of ST in various countries.

Information in this document supersedes and replaces all information previously supplied.

The ST logo is a registered trademark of STMicroelectronics. All other names are the property of their respective owners.

© 2006 STMicroelectronics - All rights reserved

STMicroelectronics group of companies

Australia - Belgium - Brazil - Canada - China - Czech Republic - Finland - France - Germany - Hong Kong - India - Israel - Italy - Japan - Malaysia - Malta - Morocco - Singapore - Spain - Sweden - Switzerland - United Kingdom - United States of America

[www.st.com](http://www.st.com)