

**LOW VOLTAGE FM XTAL CONTROLLED FRONT-END**

**ADVANCE DATA**

- RF PREAMPLIFIER
- BALANCED MIXER
- XTAL CONTROLLED OSCILLATOR (fundamental and overtone)
- LOW OSCILLATOR RADIATION
- HIGH SIGNAL HANDLING

**DESCRIPTION**

The TDA7212 is a monolithic integrated circuit in a 8 pin minidip package designed for general purpose XTAL controlled FM front-end up to 140MHz.

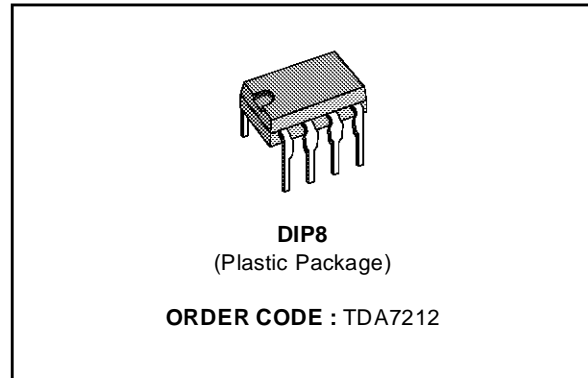

**PIN CONNECTIONS**

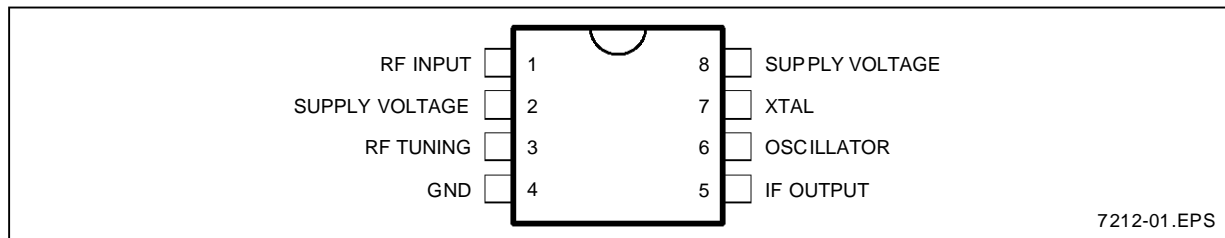

7212-01.EPS

**BLOCK DIAGRAM**

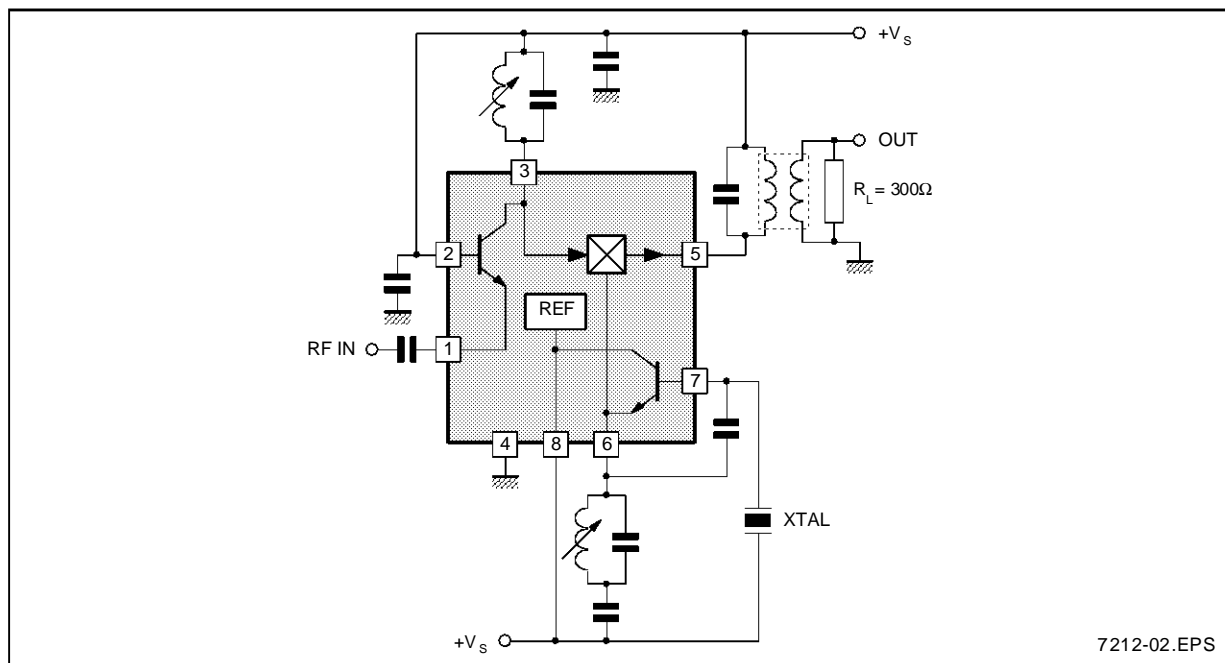

7212-02.EPS

# TDA7212

## ABSOLUTE MAXIMUM RATINGS

Symbol	Parameter	Value	Unit
$V_S$	Supply Voltage	7	V
$P_{tot}$	Total Power Dissipation at $T_{amb} < 70^\circ\text{C}$	400	mW
$T_{oper}$	Operating Temperature	-20, +85	$^\circ\text{C}$
$T_{stg}, T_j$	Storage and Junction Temperature	-40, +150	$^\circ\text{C}$

7212-01.TBL

## THERMAL DATA

Symbol	Parameter	Value	Unit
$R_{th (-a)}$	Junction-ambient Thermal Resistance	Max. 200	$^\circ\text{C/W}$

7212-02.TBL

## ELECTRICAL CHARACTERISTICS

( $V_S = 3\text{V}$ ,  $T_{amb} = 25^\circ\text{C}$  unless otherwise specified - Refer to the Test Circuit)

Symbol	Parameter	Test Conditions	Min.	Typ.	Max.	Unit
$V_S$	Supply Voltage			3	6	V
$I_S$	Supply Current			3		mA
$V_{OSC}$	Local Oscillator Voltage (Pin 6)			200		mV <sub>RMS</sub>
$G$	Voltage Gain	$f = 49\text{MHz}$ , $R_{IN} = 75\Omega$ , $R_{OUT} = 300\Omega$		40		dB
$V_{off}$	Local Oscillator Stop Voltage			1.2		V

7212-03.TBL

## TYPICAL DC VOLTAGES (Refer to the Test Circuit)

Pins	1	2	3	4	5	6	7	8
(V)	2.3	3	3	0	3	2.1	2.9	3

7212-04.TBL

## TEST CIRCUIT

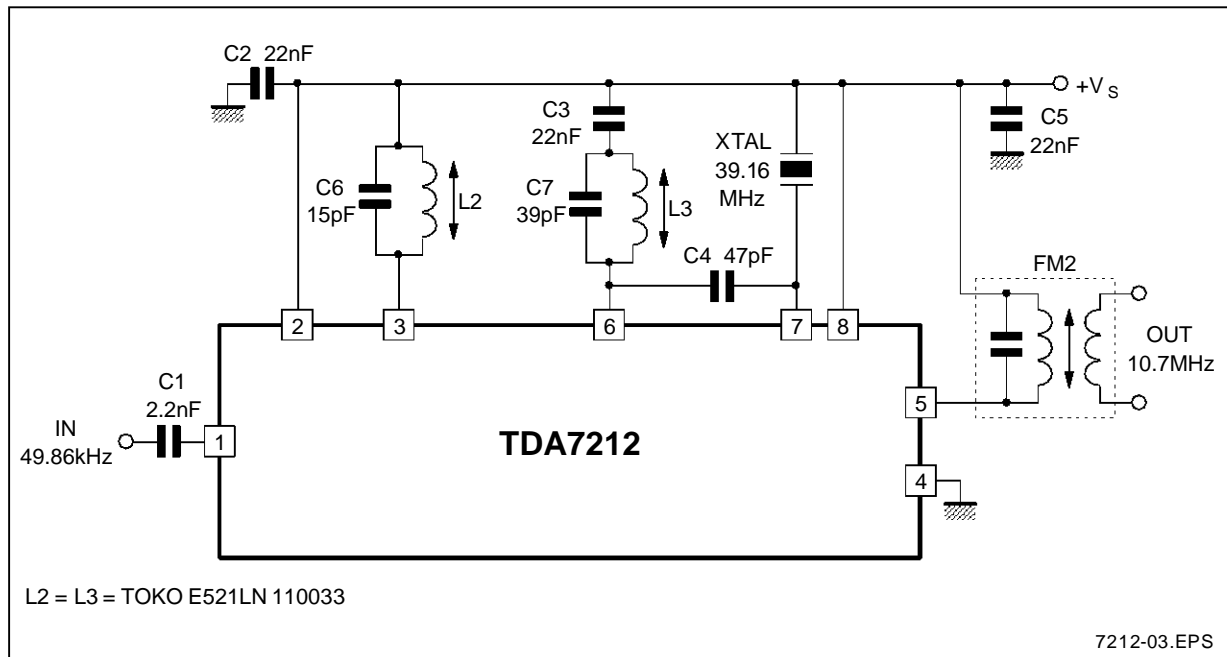

FRONT-END CORDLESS APPLICATION

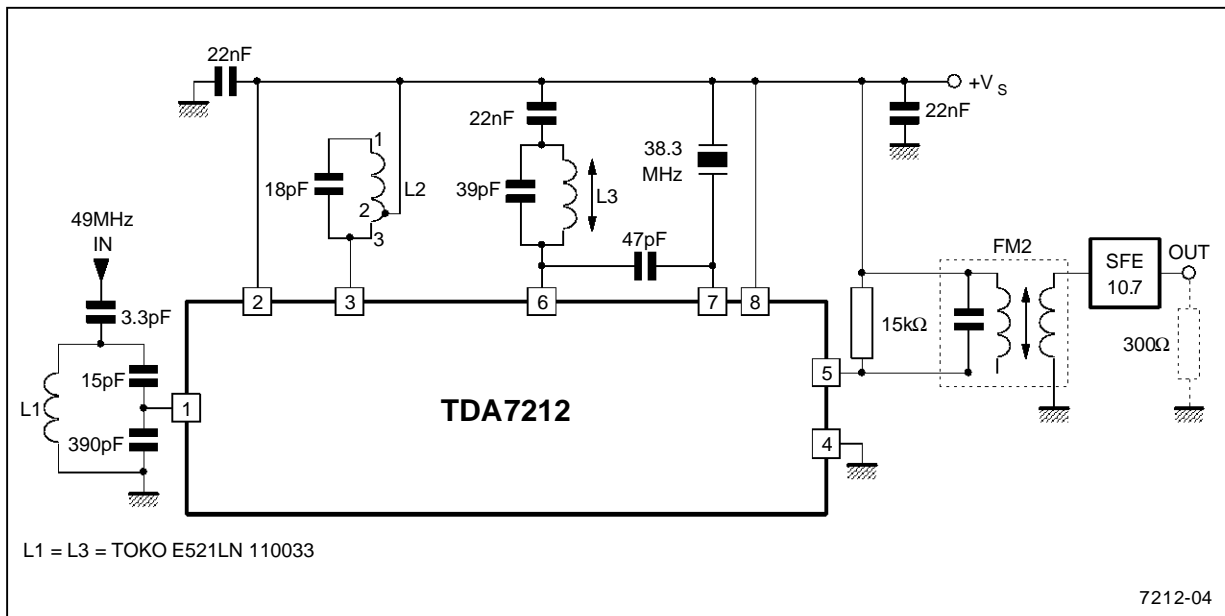

**NB.** : In this application it is advisable to decrease the gain of the front-end through a tapping on the L2 coil (3 turns of 12). So it can be obtained: better selectivity, improved intermodulation performance, better matching with the following block that are IC's designed for double conversion radio receivers.

**PACKAGE MECHANICAL DATA**

8 PINS - PLASTIC DIP

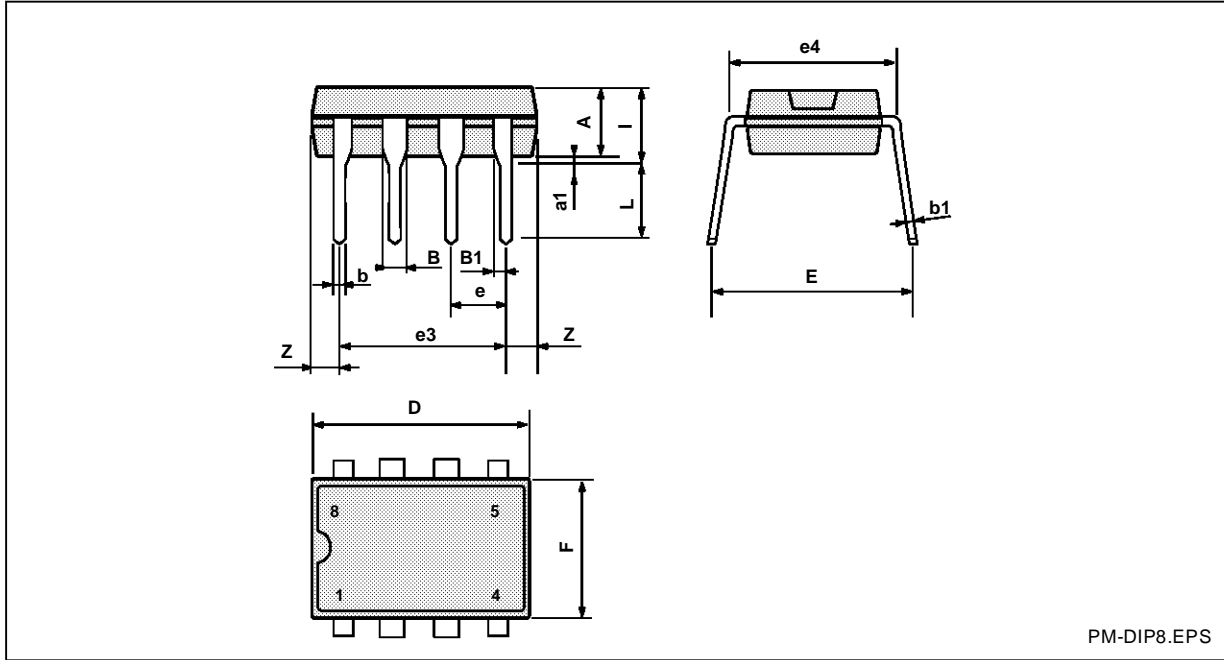

PM-DIP8.EPS

Dimensions	Millimeters			Inches		
	Min.	Typ.	Max.	Min.	Typ.	Max.
A		3.32			0.131	
a1	0.51			0.020		
B	1.15		1.65	0.045		0.065
b	0.356		0.55	0.014		0.022
b1	0.204		0.304	0.008		0.012
D			10.92			0.430
E	7.95		9.75	0.313		0.384
e		2.54			0.100	
e3		7.62			0.300	
e4		7.62			0.300	
F			6.6			0.260
i			5.08			0.200
L	3.18		3.81	0.125		0.150
Z			1.52			0.060

DIP8.TBL

Information furnished is believed to be accurate and reliable. However, SGS-THOMSON Microelectronics assumes no responsibility for the consequences of use of such information nor for any infringement of patents or other rights of third parties which may result from its use. No licence is granted by implication or otherwise under any patent or patent rights of SGS-THOMSON Microelectronics. Specifications mentioned in this publication are subject to change without notice. This publication supersedes and replaces all information previously supplied. SGS-THOMSON Microelectronics products are not authorized for use as critical components in life support devices or systems without express written approval of SGS-THOMSON Microelectronics.

© 1992 SGS-THOMSON Microelectronics - All Rights Reserved

SGS-THOMSON Microelectronics GROUP OF COMPANIES

Australia - Brazil - China - France - Germany - Hong Kong - Italy - Japan - Korea - Malaysia - Malta - Morocco  
The Netherlands - Singapore - Spain - Sweden - Switzerland - Taiwan - United Kingdom - U.S.A.

ORDER CODE :